



**INSTRUCTION MANUAL**  
**FOR WINE CELLAR**

Model Number:

**VZ47SSFG**

**VZ111SSFG**

**VZ151SSFG**

Thank you for choosing Vinvautz Wine Cellar.  
Before use, please read and follow all safety and operating instructions.

Vinvautz is the world's famous designer and manufacturer of professional Wine Cellar which manufactures Wine Cellar for your house and private dwellings. We have created aesthetic masterpieces worldwide by perfectly blending architectural elements and artistic creations in our Wine Cellar designs.

**n The Vinvautz Difference (Vin + Vautz = Wine + Safe!)**

Vinvautz is one of the first to develop a self-contained wine cellar suitable for big and small family and office with excellence in its French craftsmanship and unique stylish design sets for the needs of the trendy cosmopolitan life. Vinvautz is the famous designer and manufacturer of professional Wine Cellar and creates aesthetic masterpieces by perfectly blending architectural elements and artistic creations in its designs.

Vinvautz wine cellar is purposefully engineered for wine storage in a variety of elegant, beautiful, and stylish that enhances the ensembles in your home.

**n Digital control**

A digital control and multiple sensors ideal for storage of both red and white wine.

**n Flexible storage**

Retractable beechwood shelves are designed to provide easier accommodation.

**n Durable and High quality**

Compressor type cooling offers stability in operation and durability for long lasting storage.

# CONTENTS

DISPOSAL OF APPLIANCES.....	4
BEFORE INSTALLING AND USING YOUR NEW APPLIANCE.....	4
IMPORTANT SAFETY INSTRUCTIONS.....	4
INSTALLATION OF YOUR WINE CELLAR.....	6
BEFORE USING YOUR WINE CELLAR.....	6
INSTALLATION OF YOUR WINE CELLAR.....	6
OPERATING YOUR WINE CELLAR.....	7
CONTROL PANEL.....	7
OTHER FUNCTIONS.....	8
REVERSE THE DOOR.....	9
CARE & MAINTENANCE.....	10
PROBLEMS WITH YOUR WINE CELLAR.....	11
APPENDIX - LOADING DIAGRAM.....	12

## DISPOSAL OF APPLIANCES

Before disposing any old appliance, please remove any plugs and cut the power leads to ensure that the appliance is inoperative.

Remove the door but leave the shelves in place to prevent children climbing inside.

Dispose of your Wine Cellar packaging properly. Ensure that any plastic wrappings, bags etc. are disposed of safely and kept out of the reach of babies and young children. Danger of suffocation!



This symbol indicates that it must not be discarded as general household waste. Instead, it should be handed over to the applicable collection point for the recycling of electrical and electronic equipment. Disposal must be carried out in accordance with local environmental regulations for waste disposal.

By disposing of this product correctly you will help prevent potential negative consequences for the environment and human health, which would otherwise be caused by inappropriate waste handling of this product.

Refrigeration equipment must be properly disposed of in a professional and appropriate way, in accordance with the current local regulations and laws which protects the environment this applies to your old Wine Cellar and to your new Wine Cellar once it has reached the end of its service life.

**Warning:** When disposing of old appliance, make sure that the pipe work does not damage.

## BEFORE INSTALLING AND USING YOUR NEW APPLIANCE

**Warning:** Before powering up the appliance, please open the door for 5 minutes to ventilate the cabinet. Read through the instruction manual supplied with the appliance – failure to install or use this appliance in accordance with the instruction manual may invalidate any warranty.

The manufacturer does not accept any liability for damage caused through improper use or incorrect installation.

Do not install this appliance if it has been damaged during transportation. This includes the plug and power cord.

Please keep this instruction manual in a safe place for future reference.

**Note:** This appliance is intended to be used exclusively for the storage of wine only.

## IMPORTANT SAFETY INSTRUCTIONS

When using an electrical Wine Cellar, basic precautions should always be followed to reduce the risk of fire, electric shock, and injury to persons, including the following:

- To prevent damage to the door and door gasket, make sure the door is fully opened before pulling out any shelves.
- Do not move the wine cellar when it is loaded with wine, you might distort the appliance.
- If the power lead becomes damaged it should only be replaced by the manufacturer or a qualified person.
- Never allow children to operate, play with, or crawl inside the appliance.
- Never clean appliance parts with flammable fluids.
- Do not store or use gasoline or any other flammable vapors and liquids in the vicinity of this or any other appliance. This will cause a fire hazard or explosion.

- **Warning:** Do not allow the refrigerant circuit to become damaged while using or installing the appliance. Should it become damaged, do not use the appliance until you are instructed to do so by service engineer. Refrigerant can ignite or cause damage to the eye when leakage.
- Always remember to unplug the appliance before cleaning. When disconnecting from the electricity supply, pull the plug, not the power cord.
- Do not use anything electrical inside the wine cellar.
- All electrical repairs must be carried out by a qualified service engineer. Inadequate repairs may result in a major source of danger for the user and invalidate any warranty.
- Never store anything dangerous inside the appliance, such as combustibles, explosives, strong acid, or alkali etc.
- Always keep any ventilation openings clear of obstruction. Should they become blocked, clear them straight away.
- Make sure that the plug is in an accessible place when installation is complete.
- Only use this appliance for domestic purposes in accordance with these instructions.
- Do not connect or disconnect the electric plug when your hands are wet.
- The wine cellar is suitable for storing wine only. It is not suitable for storing fresh or frozen foods.

To avoid contamination of wine, please respect the following instructions:

- Opening the door for long periods can cause a significant increase of the temperature in the compartments of the appliance.
- Clean the surfaces that have contact with bottles regularly.
- If the refrigerating appliance is left empty for long periods, switch off, defrost, clean, dry, and leave the door open to prevent mold developing within the appliance.
- If the refrigerant of these appliances is R600a, flammable and explosive articles should not be put in or near the cabinet, to avoid the fire or explode caused.

## Warning:

- This appliance cannot be used by children aged from 8 years and below and persons with reduced physical, sensory, or mental capabilities or lack of experience and knowledge if they have not been given supervision or not play with the appliance. Cleaning and user maintenance shall not be made by children without supervision.
- Children are not allowed to load and unload wine cellar.



# INSTALLATION OF YOUR WINE CELLAR

## Before Using Your Wine Cellar

- Remove the exterior and interior packing.
- Before connecting the Wine cellar to the power source, let it stand upright for approximately 2 hours. This will reduce the possibility of a malfunction in the cooling system from handling during transportation.
- Check that the voltage marked on the product corresponds with your supply voltage.
- Clean the interior surface with lukewarm water using a soft cloth.
- When replace the illuminating lamp, please contact local service provider for replacement.
- When disposing your appliance, please choose an authorized disposal site.

## Installation of Your Wine Cellar

- Place your Wine cellar on a floor that is strong enough to support it when it is fully loaded. To level your Wine cellar, adjust the front leveling leg at the bottom of the Wine cellar.
- Locate the Wine cellar away from direct sunlight and sources of heat (stove, heater, radiator, etc.). Direct sunlight may affect the acrylic coating and heat sources may increase electrical consumption. Extreme cold ambient temperatures may also cause the unit not to perform properly.
- Avoid locating the unit in moist areas.
- Plug the Wine cellar into an exclusive, properly installed-grounded wall outlet. Do not under any circumstances cut or remove the third (ground) prong from the power cord. Any questions concerning power and/or grounding should be directed toward a certified electrician or an authorized service center.
- **Important** : If the lowest temperature is set during periods of high humidity and ambient temperature , condensation may appear on outside surfaces and the door of wine cellar, this is a normal phenomenon.

## **ATTENTION:**

This wine cellar has been designed for freestanding installation only. In every case, there must be adequate ventilation and access for service.

Freestanding installation will allow you to install the wine cellar in almost any indoor place you desired. You must follow the stated instructions for electrical requirements , recommended install area and leveling of the wine cellar.

# OPERATING YOUR WINE CELLAR

## CONTROL PANEL

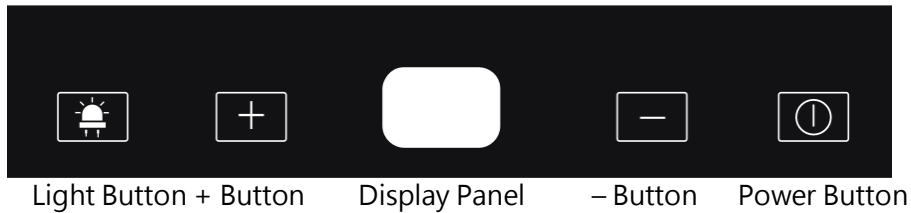

The temperature setting can be adjusted from 5°C to 18°C.



To control the appliance turn on/off.



To control the interior light ON or OFF .

To reduce energy consumption, the wine cellar will automatically switch off the internal light after 10 minutes. If you want the internal light to remain on continuously. Press and hold this button for 5 seconds until display show "LP" . To revert to normal mode. Press and hold this button for 5 seconds until display show "LF" .



Used to raise(warm) the temperature in 1°C.

The screen is set to display the actual temperature, press + or – button to display the set temperature.



Used to lower(cool) the temperature in 1°C.

The screen is set to display the actual temperature, press + or – button to display the set temperature.



To show the set temperature / actual temperature of the wine cellar.

## OTHER FUNCTIONS

### Ø To switch between °C and °F

You can select temperature display setting from Fahrenheit to Celsius degree by pushing the UP(+) and DOWN(-) button at the same time for 3 seconds.

### Ø Attention

If the unit is unplugged, power lost, or turned off, you must wait 3 to 5 minutes before restart the unit. If you need attempt to restart before this time delay, the wine cellar will not start. For first time use or longer absence of using, the temperature will difference between setting and LED display temperature. After running a certain period, the temperature will be reverted.

### Ø Temperature Memory Function

If the power is suddenly lost, the set temperature will be saved by the unit. Once the power is back on, the unit will be at the same actual temperature.

### Ø Temperature Alarm Function

If the interior temperature is higher than 23°C (73°F), "HI" is shown on the display panel and the buzzer alarm sounds continuously after one hour. This indicates that the inner temperature is too high, please look for the reason. If the inner temperature is lower than 0°C (32°F), "LO" is shown on the display panel; the alarm and the malfunction indicator light turn on at the same time.

### Ø Door Lock

Your unit is provided with a lock and key combination.

The keys are located inside the plastic bag that contains the instruction manual. Insert the key into the lock and turn it counterclockwise to unlock the door. To lock the door, do the reverse operation making sure metal pin is engaged completely. Remove the key and place it in a secure place for safekeeping.

Note: During periods of high humidity, condensation may appear on outside surfaces of the appliances.

This condensation will disappear once humidity levels drop. To prevent, it is recommended to install the appliance with sufficient ventilation in a dry and/or an air-conditioned room. Please ensure that doors are closing and sealing properly.

### Ø To remove the shelves:

To prevent damaging the door gasket, make sure to have the door all the way opened when pulling shelves out of the rail compartment.

When removing/inserting the shelves from/into the shelf track, lift one side of the shelf as shown in the picture below and pull the shelf out towards you, or push it in when inserting it, until one side is securely seated on the shelf track.

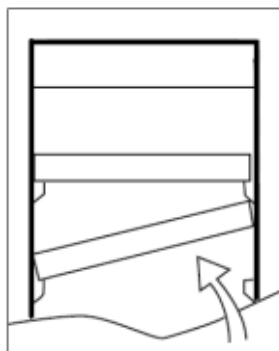



## REVERSE THE DOOR

This appliance has the capability of the door opening from either the left or right side. The unit is preset with the door opening from the left side. Should you desire to reverse the opening direction, please contact local service provider, and follow below instructions.

Open the door, remove the two screws in the bottom hinge and lift out the door.

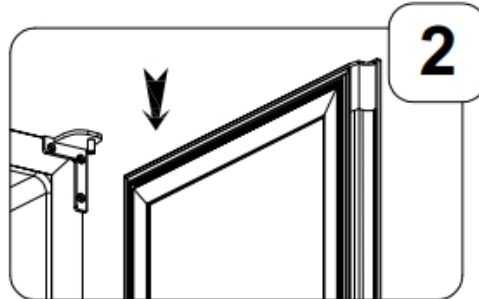
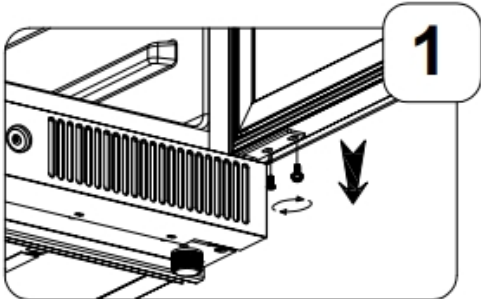

Move the plastic caps and metal nameplate on top of the door and rotate the door 180 degrees. Plastic caps and metal nameplate can be placed on the top after the door is reversed.

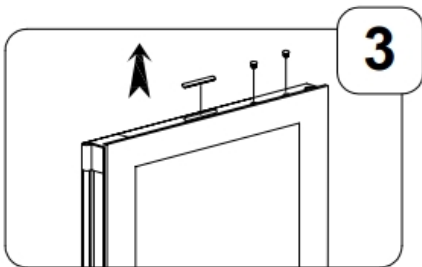

Remove the door shaft from the right upper hinge then install and tighten the left upper hinge from the plastic bag that includes the instruction manual.

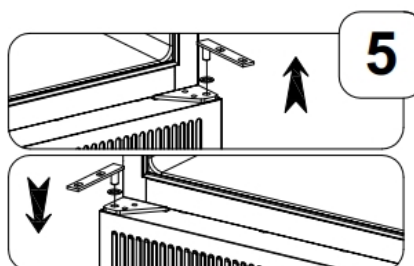
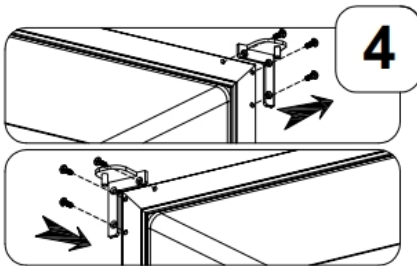

Remove the right lower hinge supporter with the adjusting washer. Install the left lower hinge supporter from the plastic bag that includes the instruction manual. Make sure to put the adjusting washers at the designated position. Mount the door and screws again.

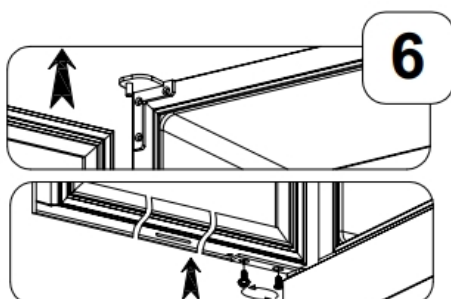

## CARE & MAINTENANCE

### Ø Clean your wine cellar

Turn off the power, unplug the appliance, and remove all items including shelves.

Wash the inside surfaces with a warm water and diluted mild detergent.

Wash the shelves with a diluted mild detergent.

Wring excess water out of the sponge or cloth when cleaning area of the controls, or any electrical parts.

Wash the outside cabinet with warm water and diluted mild liquid detergent.

Rinse well and wipe dry with a clean soft cloth.

### Ø Power failure

Most power failures are corrected within a few hours and should not affect the temperature of your appliance if you minimize the number of times the door is opened. If the power is going to be off for a long period of time, you need to take the proper steps to protect your contents.

### Ø Vacation Time

Leave the wine cellar operating during vacations of less than three weeks.

If the appliance will not be used for more than three months, remove all items and turn off the appliance. Clean and dry the interior thoroughly. To prevent odor and mold growth, leave the door open slightly, blocking it open if necessary.

Make sure there will be no children and animals climb into the appliance.

### Ø Moving your wine cellar

Remove all items.

Take out the loose items inside the wine cellar (such as shelf) or fix the loose items with the foam.

Turn the adjustable leg up to the base to avoid damage.

Tape the door shut.

Be sure the appliance stays secure in the upright position during transportation. Also protect outside of appliance with a blanket or similar item.

### Ø Energy saving tips

The wine cellar should be located in the coolest area of the room, away from heat producing appliances, and out of the direct sunlight.

Set temperature according to the characteristics of your wine to maximize energy saving.

### Ø Active carbon air filter

The active carbon air filter is located in the back of compartment.

Replace it with a new one once a year with properly use.

It can be purchased from your dealer or from the Spare Parts Department.

ÿ Remove the shelf in front of the filter.

ÿ Grip the filter and turn it 90° clockwise or anti-clockwise to remove.

ÿ Insert the new filter in the vertical position and turn it 90° clockwise or anti-clockwise until it clicks into position.

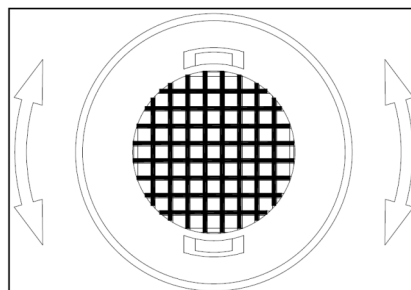

## PROBLEMS WITH YOUR WINE CELLAR

You can solve common problems by reading the suggestions below to save the cost of a possible service call. Try to see if you solve the problem before calling the service.

### Troubleshooting Guide

Problem	Possible Cause
Wine cellar does not operate	No plugged in. The appliance is turned off. The circuit breaker tripped or a blown fuse.
Wine cellar is not cold enough	Check the temperature control setting. External environment may require a higher setting. The door is always opened. The door is not closed completely. The door gasket does not seal properly.
Turns on and off frequently	The room temperature is hotter than normal. Overload of the cabinet The door is always opened. The door is not closed completely. The temperature control is not set correctly. The door gasket does not seal properly.
The light does not work	Not plugged in. The circuit breaker tripped or a blown fuse. The light bulb has burned out. The light button is "OFF"
Abnormal vibrations	Check to sure that the Wine cellar is level.
Too much noise	The rattling noise may come from the flow of the refrigerant, which is normal. As each cycle ends, you may hear gurgling. Contraction and expansion of the inside walls may cause popping and crackling noises. The wine cellar is not level.
The door will not close properly	The wine cellar is not level. The door was reversed and not properly installed. The gasket is dirty. The shelves are out of position.

# APPENDIX - LOADING DIAGRAM

## VZ151SSFG – Total 151 Bottles

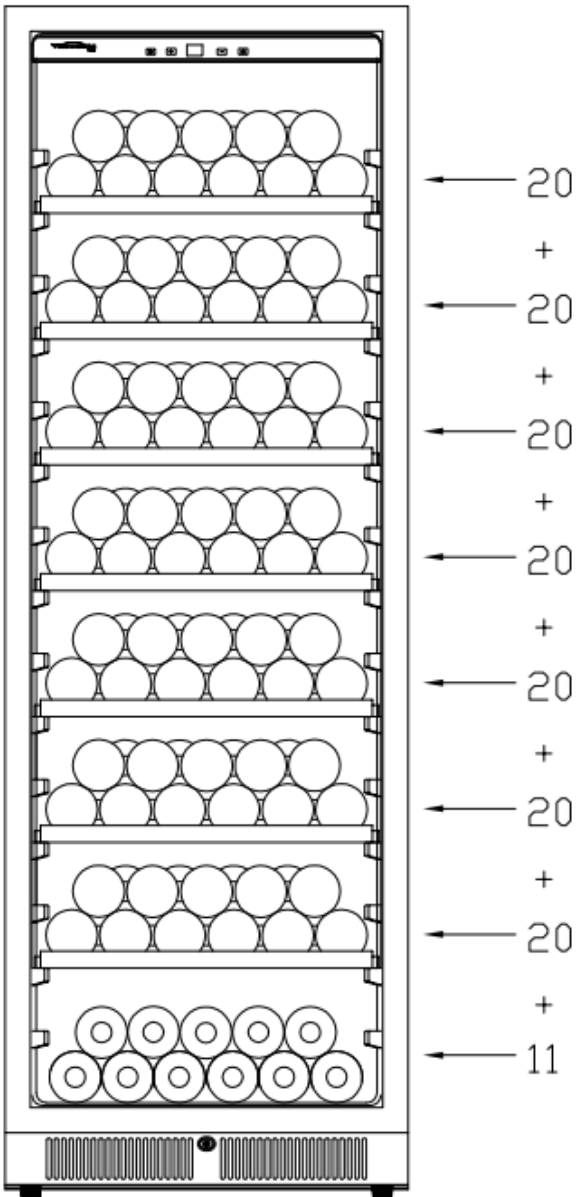

VZ111SSFG – Total 111 Bottles

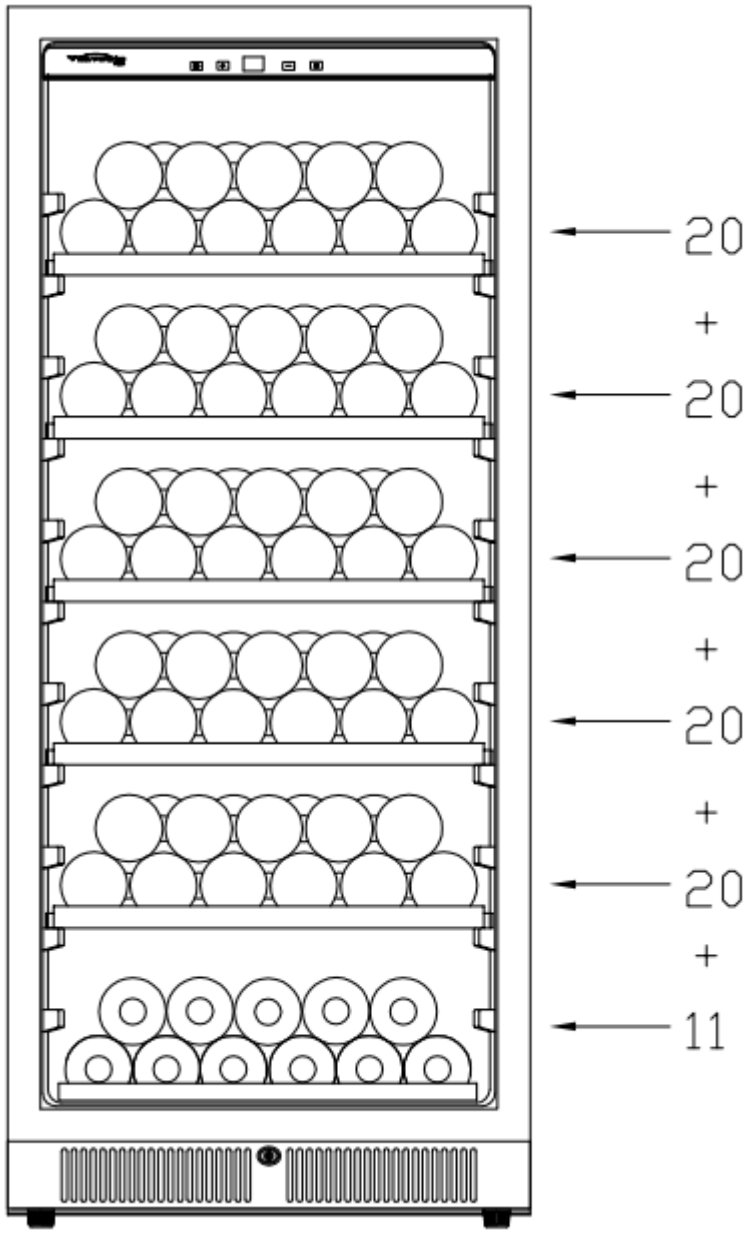

VZ47SSFG – Total 47 Bottles

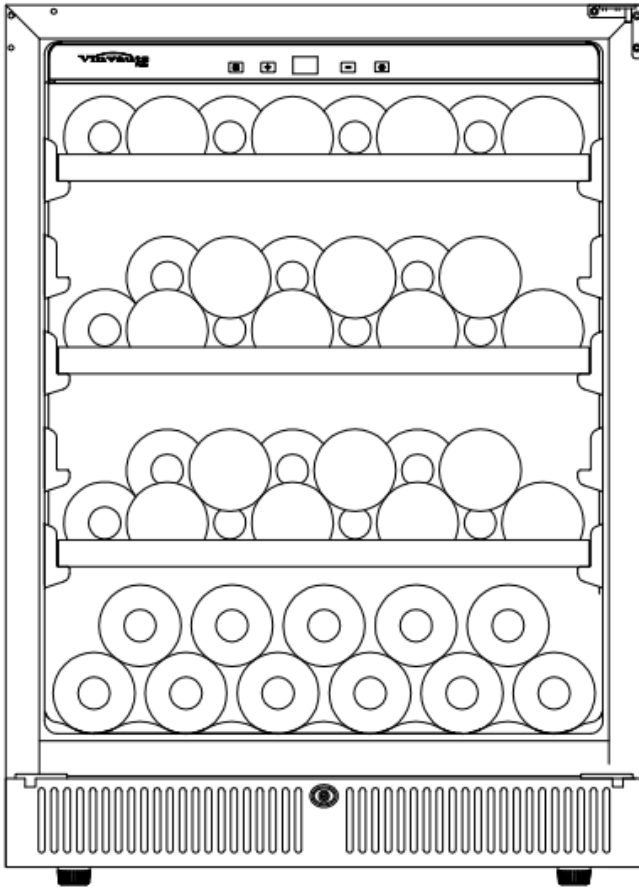

← 8  
+  
← 14  
+  
← 14  
+  
← 11



## 酒櫃操作指引

型號:

VZ47SSFG

VZ111SSFG

VZ151SSFG

非常感謝您選用此酒櫃，請仔細閱讀本說明書並妥善保存以供今後參考

**Vinvautz** 是世界著名的酒櫃製造商。多年的專業設計及生產經驗給藏酒愛好者創造了一系列混合美麗及藝術感的酒櫃。滿足愛好者在不同地方保存珍藏的嚴格要求。

**n Vinvautz 與別不同** (*Vin + Vautz = Wine + Safe !*)

Vinvautz 柔合法國設計及現代製冷技術，表現出獨特時尚品味，為家居及辦公室增添色

**n 電子操控**

獨特的設計，加上電子顯示溫度及輕觸式面板設計，方便使用。

**n 靈活實用**

附設優質櫟木層架，可自由調節高低配合實際用途。

**n 耐用可靠**

運用材料採用先進壓縮機技術，確保耐用可靠。



## 目錄

棄置酒櫃須知.....	4
使用酒櫃前注意.....	4
安全警告.....	5
安裝酒櫃.....	6
使用酒櫃之前.....	6
安裝酒櫃.....	6
酒櫃操作.....	7
操作面板.....	7
其他功能.....	8
轉改開門方向.....	9
保養與維護.....	10
故障分析.....	11
附錄 – 酒瓶裝載圖.....	12

## 棄置酒櫃須知

在棄置酒櫃之前，請拔下所有插頭和剪斷電源線以確保該設備不會進行運作。

拆卸櫃門，將酒架留在原處以防止兒童爬入內部。

請正確處置酒櫃包裝，確保處置任何塑料包裝材料，安全地存放在嬰幼兒無法觸及的地方。避免窒息！



這符號代表這產品不能以家居垃圾處理。

棄置時應將其移交給適用的回收點，以回收電器和電子零件。廢物處理必須按照當地的法律進行。

冷藏設備必須按照現行的當地法規和法律以專業及適當的方式進行適當處置，以保護環境。

這適用於您的舊酒櫃和達到使用壽命的新酒櫃。

正確處理本產品有助防止電子產品對環境和人類健康造成的潛在影響。

警告：棄置酒櫃時，請確保電線接駁沒有損壞。

## 使用酒櫃前注意

警告：在接通電源之前，請打開櫃門 5 分鐘以使機內通風。

請在使用前仔細閱讀本說明書 - 如果未按照說明書指示安裝或使用此設備，則可能導致保養失效。

因使用不當或誤用而損壞產品，製造商將不承擔任何責任。

如果在運輸過程中損壞了本設備(包括插頭和電源線)，請勿安裝本產品。

請妥善保存本說明書以供今後參考。

注意：本產品僅適用於葡萄酒的存放。

## 安全警告

使用酒櫃時，應遵循基本的預防措施，以減少著火、觸電和人身傷害的風險，包括以下內容：

- 為防止損壞櫃門和門墊，拉出任何酒架之前，請確保櫃門已完全打開。
- 不要移動裝有酒的酒櫃，否則會使設備變形。
- 若電源線損壞，必須由製造商、服務承辦商或有資格的技術人員更換。
- 本產品不能供孩子玩弄或爬入內部。
- 切勿使用易燃液體清潔本產品。
- 在本產品附近不要儲存或使用汽油或其他易燃氣體和液體，否則會引致火災或爆炸。
- 警告：在使用或安裝本產品時，請勿損壞製冷劑迴路。萬一不慎損壞，請不要使用本產品並等待有資格的技術人員指示。製冷劑洩漏時會著火或對眼睛造成傷害
- 清潔之前，請關閉本產品並拔下插頭。請勿拉動電線來拔掉電插頭。
- 請勿在櫃內使用任何電器。
- 所有維修必須由合資格的技術人員進行。維修不充分可能會給用戶帶來重大危險，並導致保養失效。
- 切勿在設備內部存放任何危險物品，例如可燃物、爆炸性物品、強酸或強鹼等。
- 保持通風孔暢通無阻。如果它們被阻塞，請立即清除它們。
- 安裝完成後，請確保將插頭放在可觸及的位置。
- 本產品僅能按照說明書作家用用途。
- 手濕時請勿連接或拔除電源插頭。
- 本產品只適合存放葡萄酒，並不適用於儲存新鮮或冷凍食品。
- 8 歲以下的孩童不允許使用本產品，身體、感官、智力有缺陷或者缺乏相關經驗、知識的人員不能在無人照看或無操作說明，不了解危險性的情況下使用本產品。
- 未成年的兒童不可以裝卸葡萄酒。
- 為避免葡萄酒受到污染並變質，請遵守以下說明：
  - 長時間打開櫃門可能會導致產品內部及部件的溫度明顯升高。
  - 定期清潔可能與酒瓶接觸的表面。
  - 如果 48 小時內未使用過水箱，則將其清洗乾淨；
- 如果設備長期空置，請關閉電源並除霜，清潔，待乾後保持櫃門打開，以防止在設備內發霉。
- 如果本設備製冷劑為 R600a，請勿在機櫃內或附近放置易燃易爆物品，以免引起火災或爆炸。



## 安裝酒櫃

### 使用酒櫃之前

- 拆除酒櫃內外包裝。
- 在酒櫃連接到電源前或移動後，讓它直立大約 2 小時。這將減少冷卻系統發生故障的可能。
- 檢查產品上標記的電壓是否與您的電源電壓相符。
- 用溫水軟布清潔機內表面。
- 當更換照明燈，請聯絡經銷商檢查維修。
- 當您棄置設備，請選擇當地法例指定的棄置場所。

### 安裝酒櫃

- 請將您的酒櫃放在一個足夠承托滿載酒櫃的樓層結構上。並在使用前調整酒櫃底部機腳以平衡您的酒櫃。
- 把酒櫃放到遠離陽光直接照射的地方和熱源（爐灶，加熱器，散熱器等）。陽光直射可能會影響塗料及機內溫度，熱源可能會增加耗電量及對存酒造成影響。極端寒冷的環境溫度也可能會導致機器不正確運作。
- 避免放到潮濕的地區。
- 正確安裝接地插座並連接酒櫃電源。在任何情況下，不要剪掉或移除電線。任何有關電力連接及操作，應該交由合資格的電工或代理商產品服務中心處理。
- **重要：**設定溫度時注意如於高溫或高濕度環境下設定最低溫度，機身及櫃門玻璃會形成冷凝水，此為正常環境影響現象。

### 注意：

本產品設計僅可用於獨立式安裝。在每種情況下，都必須有足夠的通風和維修通道。

只需遵循規定的電氣要求、安裝酒櫃地方的建議及調整酒櫃平衡的說明，您可將酒櫃安裝在任何室內場所。

## 酒櫃操作

### 操作面板



本酒櫃系列溫度設置範圍為 5°C 至 18°C。



按此鍵可啟動/關閉酒櫃。



按此鍵可啟動/關閉內部照明燈。

為了減少能源消耗。酒櫃將在 10 分鐘後自動關閉內部照明燈。

如果您希望內部照明燈持續亮著。按住此按鈕 5 秒鐘，直到顯示屏顯示 “LP”。

如要恢復到預設模式。按住此按鈕 5 秒鐘，直到顯示屏顯示 “LF”。



按此鍵可將溫度設定提高 1°C。

顯示屏預設為顯示實際溫度，按一次+或-鍵可顯示設定溫度。



按此鍵可將溫度設定降低 1°C。

顯示屏預設為顯示實際溫度，按一次+或-鍵可顯示設定溫度。



顯示設定溫度或酒櫃內實際溫度。

## 其他功能

### Ø 切換°C和°F單位

同時按下 UP ( + ) 和 DOWN ( - ) 按鈕 3 秒鐘可以切換華氏或攝氏溫度單位。

### Ø 注意

如果設備已拔除電源，斷電或關閉，必須等待 3 至 5 分鐘才能重新啟動設備。

如果您需要在此時間之前重新啟動，酒櫃將不會啟動。

如果是第一次使用或長時間沒有使用，溫度將在設置和 LED 顯示屏溫度之間變化並運行一段時間後恢復原狀。

### Ø 設定溫度記憶功能

如果酒櫃運作時突然斷電，本機將保存設定的溫度。重新啟動電源後，設備回復於預設的溫度。

### Ø 溫度警報功能

如果內部溫度高於 23°C ( 73°F )，顯示面板上會顯示 “ HI ”，持續一小時後蜂鳴器警報會響起。這表示內部溫度過高，應查找原因。

如果內部溫度低於 0°C ( 32°F )，顯示面板上會顯示 “ LO ”，警報和故障指示燈同時亮起。

### Ø 安全門鎖

本機配有門鎖和鑰匙。鑰匙位於包含使用指南的包裝袋內。

將鑰匙插入鎖中，然後逆時針旋轉以解鎖櫃門。

如要鎖定櫃門，請執行相反的操作，確保金屬片完全貼合。

拔下鑰匙並將其放置在安全的地方以進行保管。

注意：在高濕度的期間，本設備的外表面可能會形成一些冷凝水。當濕度下降時，這種冷凝水將會消失。為了預防起見，建議安裝有良好通風設備及環境乾燥或有使用冷氣機的房間，並確保櫃門已正確關閉和密封。

### Ø 卸下酒架

為免弄壞門墊，將酒架從滑軌中拉出時，請確保將櫃門完全打開

將酒架從軌道中卸下/插入時，如下圖所示，提起酒架的一側，將酒架向自己方向拉出，或者在插入時將其推入，直到一側牢固地固定在酒架上。

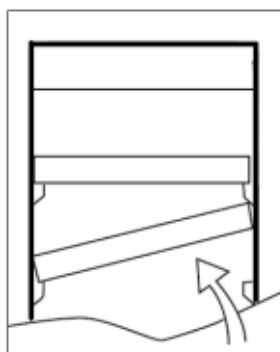

## 轉改開門方向

本設備可以選擇從左側或右側打開櫃門。

購入產品時已預定為左側打開，如果您想反向打開方向，請遵循以下步驟。

打開櫃門，卸下底部鉸鏈中的兩個螺絲，然後提起櫃門。

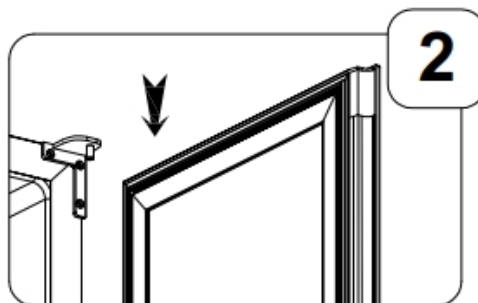
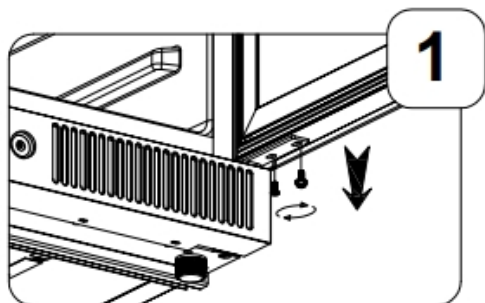

取出櫃門頂部的塑料蓋和金屬牌，並將櫃門旋轉 180 度。  
開門方向更改後，請把塑料蓋和金屬牌裝回櫃門頂部。

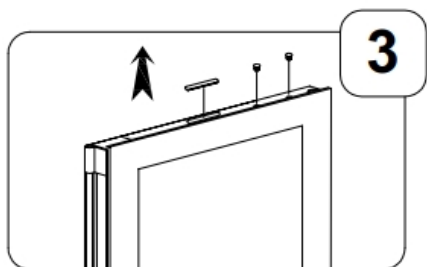

從右上鉸鏈上卸下門軸，然後從包括說明書的包裝袋中取出並安裝並擰緊左上鉸鏈。

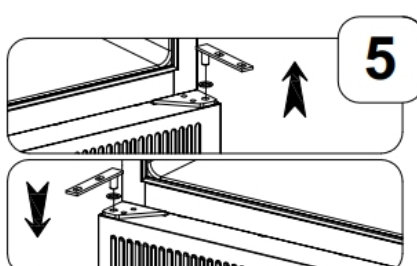
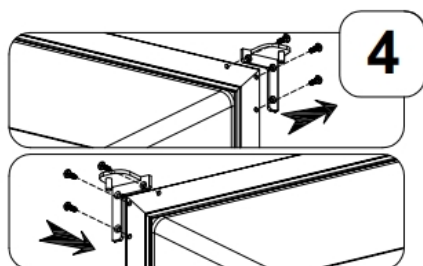

用調節墊圈卸下右下鉸鏈支架。從說明書的包裝袋中取出並安裝左下部鉸鏈支撐器。確保將調節墊圈放在指定位置。重新安裝櫃門並擰緊螺絲。

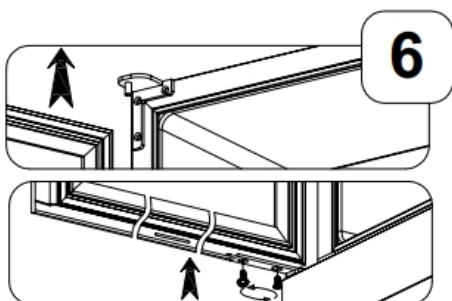

## 保養與維護

### Ø 清潔酒櫃

關閉電源，拔下電源插頭，然後取出所有物品，包括酒架。

用溫水和溫和稀釋清潔劑清潔機內表面。

用溫和和稀釋的清潔劑清潔酒架。

清潔控制顯示屏或任何電氣部件的區域時，請將多餘的水從海綿或布上擰乾方可清潔。

用溫水和中性液體洗滌劑清洗外殼，然後用乾淨的軟布擦乾。

### Ø 電源故障

如果將打開櫃門的次數減至最少，大多數電源故障會在幾小時內得到糾正，並且不會影響設備的溫度。如果要長時間關閉電源，則需要採取適當的步驟來保護您的物品。

### Ø 如酒櫃處於無人看管狀態

在三星期或以內，請讓酒櫃持續運行。

如果該設備多於三個月不使用，請除去所有物品並關閉設備。徹底清潔並乾燥內部，以防止異味和黴菌滋生。請讓櫃門稍微打開進行通風，必要時將其打開。但注意需防止有兒童及動物爬入機內。

### Ø 移動酒櫃

取出所有物品

取出酒櫃內的零散物品（例如酒架），或用物料固定。將可調式支腳向上旋轉至底座位置，以免損壞。用膠帶將櫃門關閉。

在運輸過程中，請確保將設備固定在直立位置。另外，用毯子或類似物品保護設備外部。

### Ø 節能技巧

酒櫃應放置在房間較涼爽的区域，遠離會產生熱力設備，並避免陽光直射。

溫度設定時需按照酒類的特性，按適當的溫度設定以節省能源。

### Ø 活性炭過濾網

活性炭過濾網位於隔間的背面，如妥善使用酒櫃，建議每年需要更換一次。它可以從零件部購買。

Y 卸下過濾網前面的酒架。

Y 握住過濾網，然後將其順時針或逆時針旋轉 90 度以將其取下。

Y 將新過濾網垂直插入，然後將其順時針或逆時針旋轉 90°，直至其植入到位。

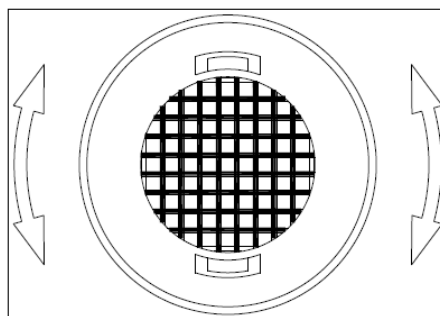



## 故障分析

您可以解決許多酒櫃常見的操作問題，從而節省了等待技術人員的支援。在致電服務之前，請嘗試以下建議以查看能否解問題。

### 故障排除指南

現象	可能的成因
酒櫃不能運作	沒有插入電源。 設備已關閉。 斷路器跳閘或保險絲燒斷。
酒櫃不夠冷	檢查溫度控制設置。 外部環境影響。 櫃門常打開。 櫃門沒有完全關閉。 櫃門墊不能正確密封。
經常啟動和關閉	室溫過高。 酒櫃超過建議載量。 櫃門常打開。 櫃門沒有完全關閉。 溫度控制設置不正確。 櫃門墊不能正確密封。
照明燈不亮	沒有插入電源。 斷路器跳閘或保險絲燒斷。 照明燈故障。 指示燈按鈕為 " OFF"
運行時出現較大震動	檢查以確保酒櫃是水平放置的。
聲響很大	可能來自製冷劑的流動，這是正常現象。 隨著每個週期的結束，您可能會聽到聲音。 內壁的收縮和膨脹可能會引起聲響。 酒櫃並沒有水平放置。
櫃門無法正確關閉	酒櫃並沒有水平放置。 開門方向被轉改但並未正確安裝。 櫃門墊很骯髒。 酒架沒有正確放置。

附錄 – 酒瓶裝載圖

VZ151SSFG – 合共 151 瓶

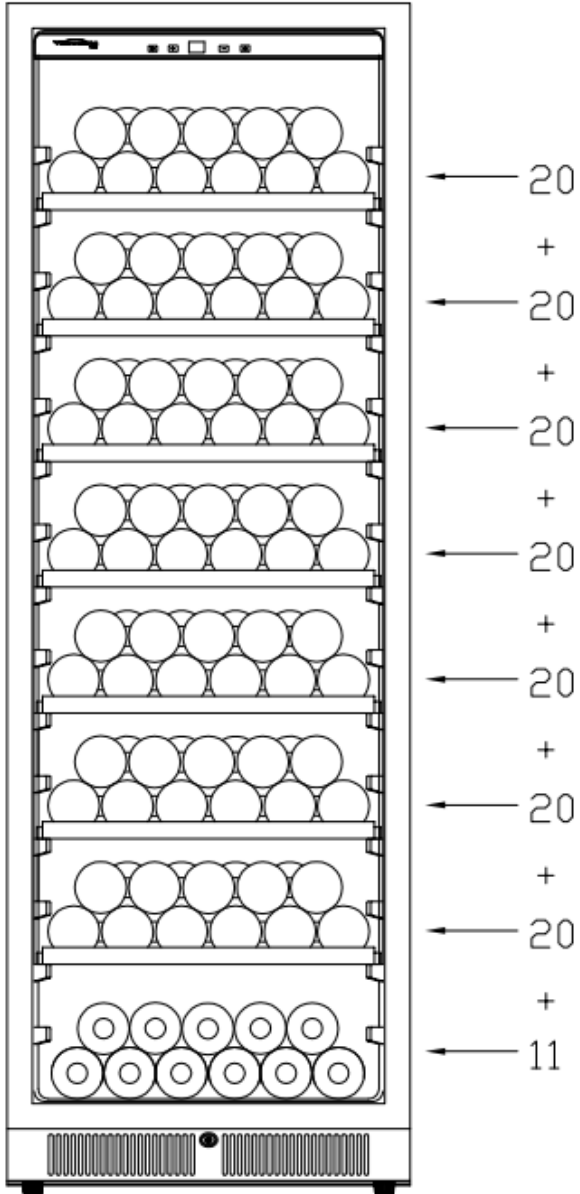

VZ111SSFG – 合共 111 瓶

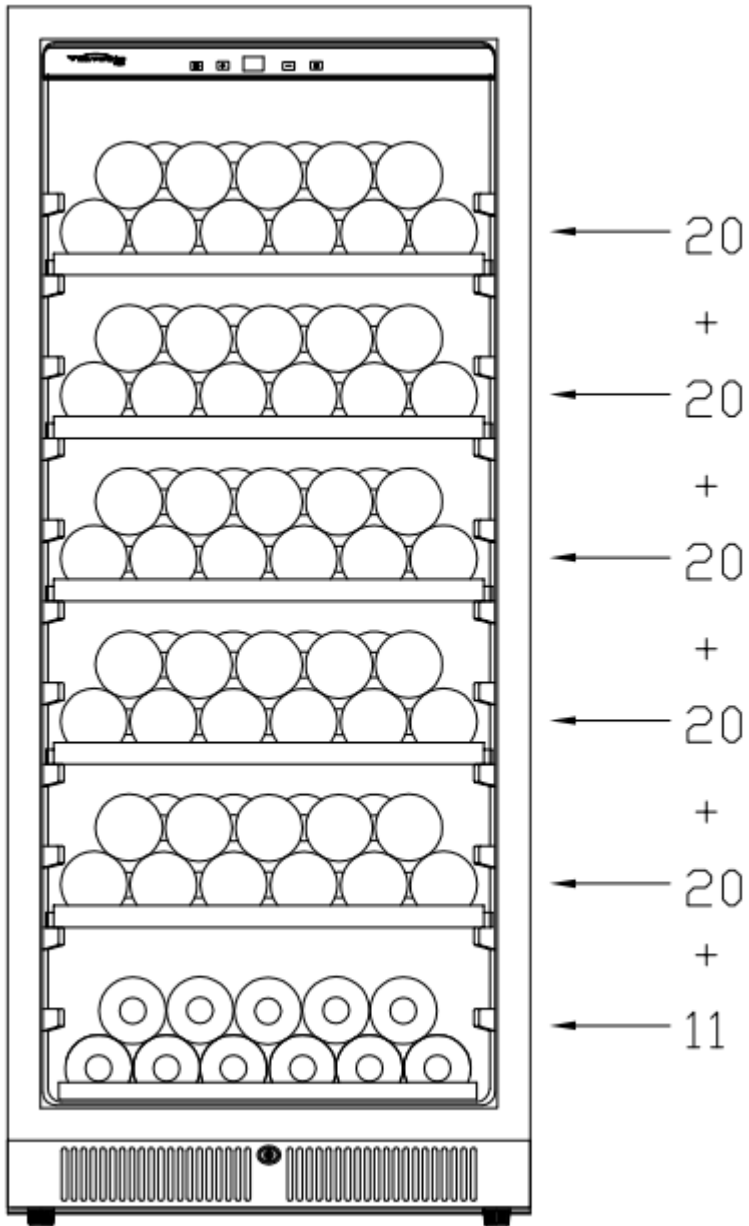

VZ47SSFG – 合共 47 瓶

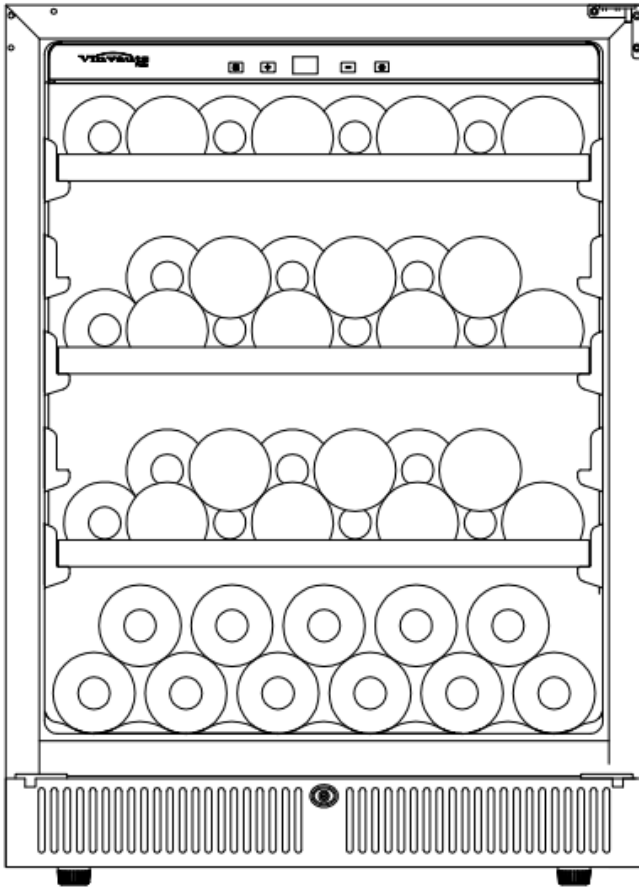

← 8  
+  
← 14  
+  
← 14  
+  
← 11

請記錄下列產品資料

- 型號 \_\_\_\_\_
- 機身編號 \_\_\_\_\_
- 經銷商名稱 \_\_\_\_\_
- 購買日期 \_\_\_\_\_

本產品不斷改進中，如功能有所更改，恕不另行通知，如有疑問，請與客戶服務中心聯絡，不便之處，敬請原諒。

說明書內容以英文版本為準

**ToolBox Customer Service Centre 客戶服務中心：**  
4/F, DCH Building, 20 Kai Cheung Road, Kowloon Bay, Hong Kong  
香港九龍灣啓祥道20號大昌行集團大廈4樓

Customer Service Hotline 客戶服務熱線：(852) 8210 8210  
Service E-mail 電郵地址：8210service@gilman-group.com  
Please register now at 請即上網登記：www.toolbox.hk  
Website 網址：www.gilman-group.com



Proudly Serviced by:



**太平家庭電器**

  
**Vinvautz**  
France