

# 使用安裝說明書

## 三菱重工 窗口式空調器

ENGLISH

MITSUBISHI HEAVY INDUSTRIES  
WINDOW TYPE AIR-CONDITIONER

中文

### USER'S MANUAL

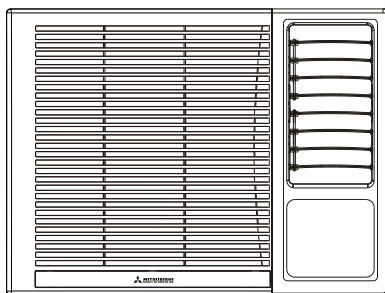

WRK20MD2

WRK26MD2

WRK35MD2

WRK53MD2

承蒙選購三菱重工空調器，深表感謝！為了使空調器長久保持其良好的運轉性能，在您開始使用空調器之前，務請仔細閱讀本說明書。閱後應將它妥善保管好，以備必要時查閱。

本空調器使用新型環保冷媒(R410A)，當需要獲得維修檢查以及保養時，請對經銷商說明此情況。

本空調器適用於家用。



## Read This Manual

Inside you will find many helpful hints on how to use and maintain your air conditioner properly. Just a little preventive care on your part can save you a great deal of time and money over the life of your air conditioner. You'll find many answers to common problems in the chart of troubleshooting tips. If you review our chart of Troubleshooting Tips first, you may not need to call for service at all.

### CAUTION

- This appliance can be used by children aged from 8 years and above and persons with reduced physical, sensory or mental capabilities or lack of experience and knowledge if they have been given supervision or instruction concerning use of the appliance in a safe way and understand the hazards involved. Children shall not play the appliance. Cleaning and user maintenance shall not be made by children without supervision. ( be applicable for the European Countries )
- This appliance is not intended for use by persons (including children) with reduced physical ,sensory or mental capabilities or lack of experience and knowledge, unless they have been given supervision or instruction concerning use of the appliance by a person responsible for their safety. (be applicable for other countries except the European Countries )
- Children should be supervised to ensure that they do not play with the appliance.
- If the supply cord is damaged, it must be replaced by the manufacturer, its service agent or similarly qualified persons in order to avoid a hazard.
- The appliance shall be installed in accordance with national wiring regulations.
- Do not operate your air conditioner in a wet room such as a bathroom or laundry room.
- The appliance with electric heater shall have at least 1 meter space to the combustible materials.
- Contact the authorised service technician for repair or maintenance of this unit.
- Contact the authorised installer for installation of this unit.
- When there are wide differences between “USER’S MANUAL” and “Remote controller Illustration” on function description, the description on “USER’S MANUAL” shall prevail.
- If the air conditioner is knocked over during use, turn off the unit and unplug it from the main power supply immediately. Visually inspect the unit to ensure there is no damage. If you suspect the unit has been damaged, contact a technician or customer service for assistance.
- In a thunderstorm, the power must be cut off to avoid damage to the machine due to lightning.
- To reduce the risk of fire or electric shock, do not use this fan with any solid-state speed control device.
- Do not run cord under carpeting. Do not cover cord with throw rugs, runners, or similar coverings. Do not route cord under furniture or appliances. Arrange cord away from traffic area and where it will not be tripped over.

## CONTENTS

1. SAFETY PRECAUTIONS.....	1
2. UNIT PARTS IDENTIFICATION.....	7
3. OPERATING INSTRUCTIONS .....	8
4. INSTALLATION INSTRUCTIONS.....	13
5. TROUBLESHOOTING .....	16
6. SPECIFICATIONS .....	17

### Read This Manual



Inside you will find many helpful hints on how to use and maintain your air conditioner properly. Just a little preventive care on your part can save you a great deal of time and money over the life of your air conditioner. You'll find many answers to common problems in the chart of troubleshooting tips. If you review our chart of troubleshooting tips first, you may not need to call for service at all.

## CAUTION

1. Contact the authorised service technician for repair or maintenance of this unit.
2. Contact the authorised service technician for installation of this unit.
3. The air conditioner is not intended for use by persons (including children) with reduced physical, sensory or mental capabilities, or lack of experience and knowledge, unless they have been given supervision or instruction concerning use of appliance by a person responsible for their safety.
4. Children should be supervised to ensure that they do not play with the air conditioner.
5. If the power cord is damaged, it must be replaced by the manufacturer, the authorised service technician or qualified person in order to avoid a hazard.
6. Make sure the unit power and the circuit breaker are turned off before cleaning and maintenance.

## SAFETY PRECAUTIONS

To prevent injury to the user or other people and property damage, the following instructions must be followed. Incorrect operation due to ignoring of instructions may cause harm or damage. The seriousness is classified by the following indications.

 <b>WARNING</b>	This symbol indicates the possibility of death or serious injury.
 <b>CAUTION</b>	This symbol indicates the possibility of injury or damage to property.

### **WARNING**

- Plug in power plug properly. Otherwise, it may cause electric shock or fire due to excess heat generation.
- Do not operate or stop the unit by inserting or pulling out the power plug. It may cause electric shock or fire due to heat generation.
- Do not damage or use an unspecified power cord. It may cause electric shock or fire. If the power cord is damaged, it must be replaced by the manufacturer or an authorised service centre or a similarly qualified person in order to avoid a hazard.
- Do not modify power cord length or share the outlet with other appliances. It may cause electric shock or fire due to heat generation.
- Do not operate with wet hands or in damp environment.  
It may cause electric shock.
- Do not direct airflow at room occupants only. This could damage your health.
- Always ensure effective earthing. Incorrect earthing may cause electric shock.
- Do not allow water to run into electric parts.  
It may cause failure of machine or electric shock.
- Always install circuit breaker and a dedicated power circuit.  
Incorrect installation may cause fire and electric shock.
- Unplug the unit or disconnect the power supply to the unit if strange sounds, smell, or smoke comes from it.  
It may cause fire and electric shock.
- Do not use the socket if it is loose or damaged.  
It may cause fire and electric shock.
- Do not open the unit during operation. It may cause electric shock.
- Leave the door closed while the air conditioner is running.  
It is not designed to cool the entire house.

- Do not use the power cord close to heating appliances.  
It may cause fire and electric shock.
- Do not use the power cord near flammable gas or combustibles, such as gasoline, benzene, thinner, etc. It may cause an explosion or fire.
- Ventilate room before operating air conditioner if there is a gas leakage from another appliance.  
It may cause explosion, fire and burns.
- Do not disassemble or modify unit. It may cause failure and electric shock.

### **CAUTION**

- When the air filter is to be removed, do not touch the metal parts of the unit.  
It may cause an injury.
- Do not clean the air conditioner with water.  
Water may enter the unit and degrade the insulation. It may cause an electric shock.
- Ventilate the room well when used together with a stove, etc.  
An oxygen shortage may occur.
- When the unit is to be cleaned, switch off, and turn off the circuit breaker.  
Do not clean unit when power is on as it may cause fire and electric shock, it may cause an injury.
- Do not put a pet or house plant where it will be exposed to direct air flow.  
This could injure the pet or plant.
- Do not use for special purposes. Do not use this air conditioner to preserve precision devices, food, pets, plants, and art objects.  
It may cause deterioration of quality, etc.
- Stop operation and close the window in storm or hurricane.  
Operation with windows opened may cause wetting of indoor and soaking of household furniture.
- Hold the plug by the head of the power plug when taking it out.  
It may cause electric shock and damage.
- Turn off the main power switch when not using the unit for a long time.  
It may cause failure of product or fire.
- Do not place obstacles around air-inlets or inside of air-outlet.  
It may cause failure of appliance or accident.
- Always insert the filters securely. Clean filter once every two weeks.  
Operation without filters may cause failure.

- Ensure that the installation bracket of the outdoor appliance is not damaged due to prolonged exposure. If bracket is damaged, there is concern of damage due to falling of unit.
- Do not use strong detergent such as wax or thinner but use a soft cloth. Appearance may be deteriorated due to change of product color or scratching of its surface.
- Do not place heavy object on the power cord and ensure that the cord is not compressed. There is danger of fire or electric shock.
- Do not drink water drained from air conditioner. It contains contaminants and could make you sick.
- Use caution when unpacking and installing. Sharp edges could cause injury.
- If water enters the unit, turn the unit off at the power outlet and switch off the circuit breaker. Isolate supply by taking the power-plug out or disconnect the power supply to the unit and contact a qualified service technician.
- This appliance can be used by children aged from 8 years and above and persons with reduced physical, sensory or mental capabilities or lack of experience and knowledge if they have been given supervision or instruction concerning use of the appliance in a safe way and understand the hazards involved. Children shall not play with the appliance. Cleaning and user maintenance shall not be made by children without supervision. (be applicable for the European Countries )
- This appliance is not intended for use by persons (including children) with reduced physical ,sensory or mental capabilities or lack of experience and knowledge, unless they have been given supervision or instruction concerning use of the appliance by a person responsible for their safety. (be applicable for other countries except the European Countries )
- Children should be supervised to ensure that they do not play with the appliance.
- If the supply cord is damaged, it must be replaced by the manufacturer, its service agent or similarly qualified persons in order to avoid a hazard.
- The appliance shall be installed in accordance with national wiring regulations.

- Do not operate your air conditioner in a wet room such as a bathroom or laundry room.
- The appliance with electric heater shall have at least 1 meter space to the combustible materials.
- Contact the authorised service technician for repair or maintenance of this unit.
- Contact the authorised installer for installation of this unit.
- When there are wide differences between “USER’S MANUAL” and “Remote controller Illustration” on function description, the description on “USER’S MANUAL” shall prevail.
- If the air conditioner is knocked over during use, turn off the unit and unplug it from the main power supply or disconnect the power supply to the unit immediately. Visually inspect the unit to ensure there is no damage.
- If you suspect the unit has been damaged, contact a technician or customer service for assistance.
- In a thunderstorm, the power must be cut off to avoid damage to the machine due to lightning.
- To reduce the risk of fire or electric shock, do not use this fan with any solid-state speed control device.
- Do not run cord under carpeting. Do not cover cord with throw rugs, runners, or similar coverings. Do not route cord under furniture or appliances. Arrange cord away from traffic area and where it will not be tripped over.
- If connecting power to fixed wiring, an all-pole disconnection device which has at least 3mm clearances in all poles, and have a leakage current that may exceed 10mA, the residual current device(RCD) having a rated residual operating current not exceeding 30mA, and disconnection must be incorporated in the fixed wiring in accordance with the wiring rules.
- How to fix the appliance to its support, please read the “installation instructions” section in this manual.
- All wiring must be performed strictly in accordance with the wiring diagram located inside of the unit.



## **SAFETY PRECAUTIONS(prior to operation)**

### **Preparing for operation**

1. Contact an installation specialist for installation.
2. Plug in the power plug properly.
3. Do not use a damaged or non-standard power cord.
4. Do not share the same outlet with other appliances.
5. Do not use an extension cord.
6. Do not start/stop operation by plugging/unplugging the power cord.

### **Usage**

1. Exposure to direct airflow for an extended period of time could be hazardous to your health. Do not expose occupants, pets or plants to direct airflow for extended periods of time.
2. Due to the possibility of oxygen deficiency, ventilate the room when used together with stoves or other heating devices.
3. Do not use this air conditioner for non-specified special purposes (e.g. Preserving precision devices, food, pets, plants, and art objects). Usage in such a manner could harm such property.

### **Cleaning and maintenance**

1. Do not touch the metal parts of the unit when removing the filter. Injuries can occur when handling sharp metal edges.
2. Do not use water to clean inside the air conditioner. Exposure to water can destroy the insulation, leading to possible electric shock.
3. When cleaning and maintenance the unit, first make sure that the power and circuit breaker are turned off.

## Operating Temperature

Cooling operation	Outdoor temp:	18-43°C
	Indoor temp:	17-32°C/62-90°F
	NOTE: It may be condensed water on the surface of unit if humidity (RH) operation setting of unit is high than 80% however room humidity(RH) lower than 80% .	

**Note:** Performance may be reduced outside of these operating temperatures.

### Power point requirement

1. Power cord conductors are distinguished according to color as follows (see Fig.a)
2. For your safety and protection, this unit is earthed through the power cord (see Fig.a)  
Please contact the manufacturer or its service agent or a similar qualified person if you want to replace it. (see Fig.b)
3. Be sure that the unit being correctly grounded. The wall outlet (Air-break switch) should be provided with reliable earth wire.
4. The unit should be provided with an individual circuit and the circuit breaker/fuse rating should be the same as that of the power cord and wall outlet.

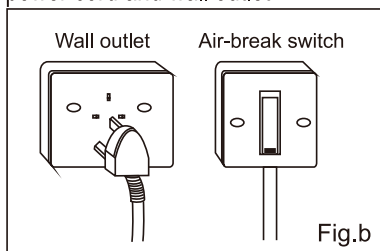
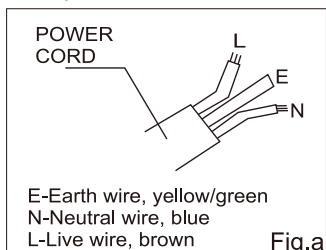

NOTE: To be in compliance EN61000-3-11, the product MWT2F-21CM-QB4 shall be connected only to a supply of the system impedance:  $|Z_{sys}|=0.156$  ohms or less; the product MWT2F1-22CM-QB4 shall be connected only to a supply of the system impedance:  $|Z_{sys}|=0.132$  ohms or less; the product MWT2F1-22CM-QB8 shall be connected only to a supply of the system impedance:  $|Z_{sys}|=0.077$  ohms or less. Before connect the product to public power network, please consult your local power supply authority to ensure the power network meet above requirement.

**CAUTION:** Before installing, remove all packaging from inside the carton, along with any inserts placed into the side louvers.

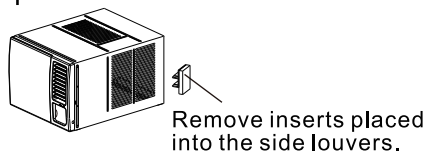
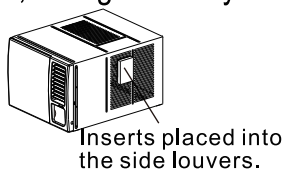



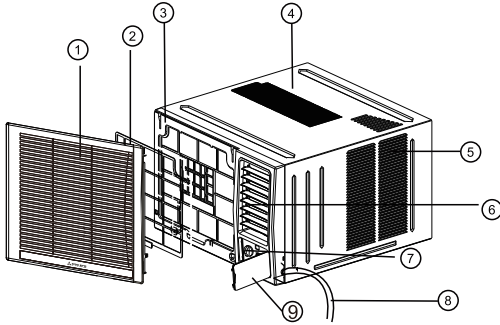

## UNIT PARTS IDENTIFICATION

**NOTE:** The front panel and cabinet may be slightly different according to the models, but the functions are the same. The following illustration is for explanation purpose only, the actual shape of the machine you purchased may be slightly different.



1. Front panel
2. Air filter
3. Frame
4. Cabinet
5. Air inlet grille (outdoor side)
6. Air outlet grille
7. Operation knob
8. Power supply cord
9. Control panel cover

### Accessories

Seal (※) (Used on drain joint)    1 pc	Drain Joint(※)    1 pc	Drain Tray (※)    1 pc	Screw    2 pcs (≤12000Btu) 4 pcs (≥18000Btu)
---	---	---	--

**NOTE: Optional parts(※), depending on model you purchased.**

**NOTE:**All the illustrations in the manual are for explanation purpose only. Your air conditioner may be slightly different. The actual shape shall prevail.

### Vent Control

The vent control is located above the control knobs. The operation method is different on different models (see the following figures).

For maximum cooling efficiency, CLOSE the vent. It will allow internal air circulation. OPEN the vent to discharge stale air.

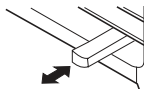

CLOSE ← VENT → OPEN

To open the vent, pull the lever toward you  
To close it, push it in.

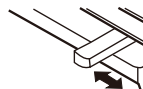

CLOSE ← VENT → OPEN

To open the vent, set the lever to the right position  
To close it, set the lever to the left position.

# OPERATING INSTRUCTIONS

## OPERATION PANEL(Cooling only models)

The control panel of the unit you purchased may look like one of the followings:

Models 7200~8800Btu/h

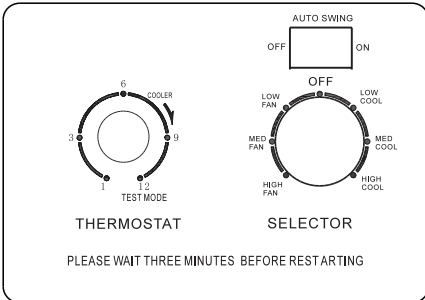

Models 12000~18000Btu/h

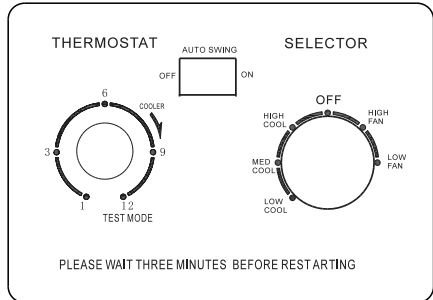

### NOTE:

**TEST MODE** is used to test the compressor and make sure unit is working properly. Do not use this position for regular operation.

### NOTE:

AUTO SWING switch is optional. All the illustrations in this manual are for explanation purpose only. Your air conditioner may be slightly different. The actual shape shall prevail.

## **Operation instructions**

The controls featured in this manual are representative of many available models. Your model may offer slightly different features.

### **SELECTOR**

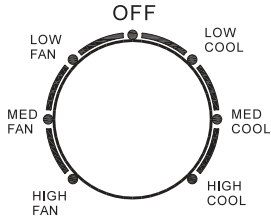

Models 7200~12000Btu/h

### **COOL MODE**

The desired cool setting is selected by rotating the knob to the right to the appropriate location.

“HIGH COOL” has maximum cooling effect and airflow.

“MED COOL” has the intermediate cooling effect and airflow.

“LOW COOL” has minimum cooling effect and airflow.

“OFF” will completely shut off the unit.

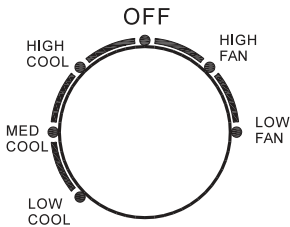

Model 18000Btu/h

### **FAN MODE**

“HIGH FAN” permits high fan speed operation without cooling effect.

“MED FAN” permits med fan speed operation without cooling effect.

“LOW FAN” permits low fan speed operation without cooling effect.

“FAN” permits high fan speed operation without cooling effect.

Note: When selecting a fan speed, the compressor will not run.

### **Note**

When turning the SELECTOR knob from “LOW COOL” to “HIGH COOL”, keep your speed slow as far as possible. Do not change the operation mode between “LOW COOL” and “HIGH COOL” too often.

## ADJUST AIR FLOW DIRECTION

### Horizontal airflow adjustment

For the units with **AUTO SWING** feature(automatically)(on some models):

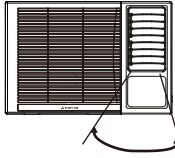

When the **AUTO SWING** switch is turned to “**ON**” position, the vertical louvers automatically oscillate right and left sweeping the cold air alternately to obtain comfortable cooling. The vertical louvers may be stopped at any position when the **AUTO SWING** switch is turned “**OFF**” .

For the units without **AUTO SWING** feature(manually):

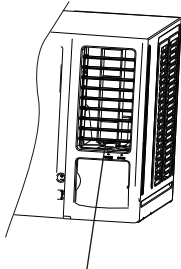

Hand-operating lever

To adjust horizontal airflow direction, move the lever gently to the left or right by hand until the desired horizontal airflow direction is obtained.

**NOTE: Only For the units with hand-operating lever.**

## OPERATING INSTRUCTIONS(continued)

### Vertical air flow adjustment (manually)

Up horizontal louver

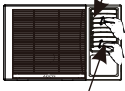

Low horizontal louver

Airflow in vertical direction can be changed by adjusting horizontal louver manually when the unit is running.

NOTE: Adjusting angle of horizontal louver depends on models.

To avoid generating condensing water on the surface of horizontal louver, horizontal louver should not be at the maximum upwards or downwards angle position for a long time in cooling or drying mode.

### Air Filter

The air filter behind the inlet grille should be checked and cleaned at least once every 2 weeks (or as necessary) to maintain optimal performance of the air conditioner.

#### How to remove the air filter

Turn off the unit, disconnect /unplug from the power supply.

1. Hold the tabs under the front panel, then uplift it outwards, and remove the front panel.
2. Pinch the handle under the air filter and make the air filter arched, remove it from the slot from underside to upside.
3. Clean the filter with warm, soapy water. The water should be below 40°C to prevent distortion of the filter.
4. Rinse off and gently shake off excess water from the filter. Allow the filter to dry before replacing it. To prevent distortion of the filter, do not dry in direct sunlight.

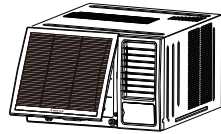

### Air Freshen Filter(optional)

The air freshen filter can be installed at any place of the four positions.

#### How to install the air freshen filter

1. Remove the air filter as the steps above.
2. Install the air freshen filter to the positions you desired as shown in the right picture.

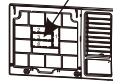

#### Cabinet Cleaning

- Be sure to unplug the air conditioner to prevent shock or fire hazard. The cabinet and front may be dusted with an oil-free cloth or washed with a cloth dampened in a solution of warm water and mild liquid dishwashing detergent. Rinse thoroughly and wipe dry.
- Never use harsh cleaners, wax or polish on the cabinet front.
- Be sure to wring excess water from the cloth before wiping around the controls.
- Excess water in or around the controls may cause damage to the air conditioner.
- Plug in air conditioner.

**NOTE:** Never use water over 50 °C, alcohol, gasoline, acid, solvent or brush to clean the front panel as this will damage the surface of the part.

#### Winter Storage

If you plan to store the air conditioner during the winter, remove it carefully from the window according to the installation instructions. Cover it with plastic or return it to the original carton.

## OPERATING INSTRUCTIONS(continued)



**NEVER operate the air conditioner without the air filter, as dust/dirt particles can contribute to equipment failure.**

### Drainage

To treat condensed water will be as follows:

1. Bottom drainage. Connect drain hose to the bottom drain tray. It will slightly affect cooling performance, but will reduce the noise caused by spraying the condensed water.  
Note: Only optional for models with bottom drain hole. For pump heating, the bottom drainage must be choosed.
2. Back drainage. Connect drain hose to the back drainage hole. It will slightly affect cooling performance, but will reduce the noise caused by spraying the condensed water.
3. Non-drainage. Block the drain hole(s) by rubber plug(s).  
The condensed water will be sprayed to condenser, and will improve the cooling performance.

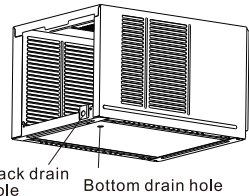

Installation procedures of bottom drainage:

- Remove the rubber plug from the bottom of cabinet(if installed).
- Take out the drain tray and screws from accessory.
- Fix the drain tray onto the bottom of cabinet by screws.
- Connect an extension drain hose (locally purchased) to the outlet of drain tray.

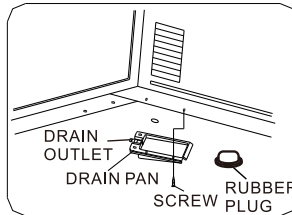
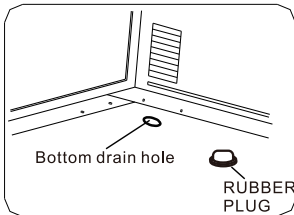

Installation procedures of back drainage:

- Fit the seal (provided as accessory) onto the drain joint.
  - Insert the drain joint to the back drainage hole, and rotate it by 90° to be well fitted.
  - Connect an extension drain hose (locally purchased) to the drain joint.
  - Make sure block the bottom drain hole by rubble plug.
- Note: Drain hose is locally purchased according to installation length request.

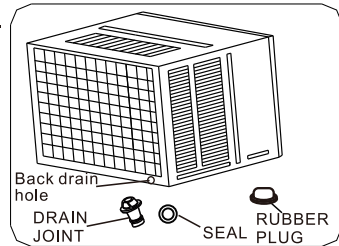

NOTE: If you choose non-drainage when cooling, both the bottom and the back drain holes of the unit should be inserted with rubber plugs. When you choose non-drainage the air conditioner will be perfect cooling efficiency, but big noise may be caused by spraying the condensed water. Does not recommend to use.

NOTE: The rated cooling performance is tested under non-drainage status.

NOTE: Make sure that water will not leak from the surrounding area when rubber plug and joint were used. Please seal it in case leakage is found.



## INSTALLATION INSTRUCTIONS

**NOTE:** Before installing, remove all packaging from inside the carton, along with any inserts placed into the side louvers.

### Select the best location

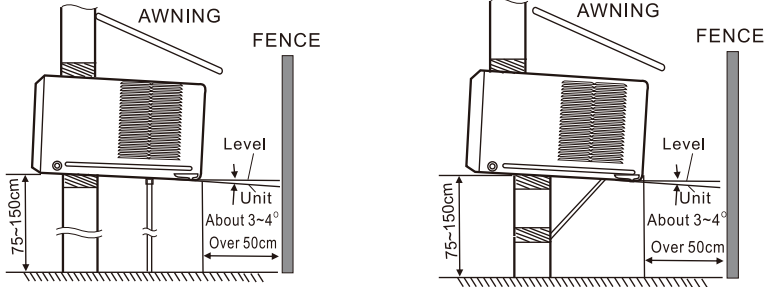

1. To avoid vibration and noise, make sure the unit is installed securely and firmly.
2. Install the unit where the sunlight does not shine directly on the unit.  
If the unit receives direct sunlight, build an awning to shade the cabinet.
3. There should be no obstacle, such as a fence or wall, within 50cm from the back of the cabinet because it will prevent heat radiation of the condenser. Restriction of outside air will greatly reduce the cooling and heating efficiency of the air conditioner.
4. Install the unit a little obliquely downward to outside not to leak the condensed water into the room (about 3~4° with level).
5. Install the unit with its bottom portion 75~150cm above the floor level.
6. The power cord must be connected to an independent circuit. The yellow/green wire must be grounded.

### CAUTION

All side louvers of the cabinet must remain exposed to the outside of the structure.

### Installation of the Housing

#### Step 1

Remove the air conditioner from its packaging, remove fixing screws and slide the air conditioner out of its housing (Refer to Installation Steps).

#### Step 2

Prepare the hole in the wall so that the bottom of the housing is well supported, the top has minimum clearance and the air inlet louvers have clearance as shown below in options A and B. Holes from the outside through to the cavity should be sealed. The housing should slope down towards the rear by about 5mm to allow water formed during operation to drain.

#### Step 3

Install the housing into the wall and secure. Ensure the foam seals are not damaged. Flash, seal or fill gaps around the inside and outside to provide satisfactory appearance and protection against the weather, insects and rodents.

**NOTE:** UNIT MAY BE SUPPORTED BY A SOLID FRAME FROM BELOW OR BY A HANGER FROM A SOLID OVERHEAD SUPPORT. FLASH OR SEAL AROUND EXTERNAL WALL FRAME OR ARCHITRAVE

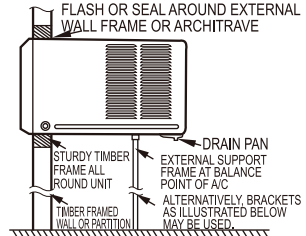

Preferred method of installation into a timber framed wall, partition or window.

## Installation of the unit into the Housing

1. Slide the unit into the housing until it is firmly against the rear of the housing. Care is required to ensure the foam sealing strips on the housing remain in position.
2. Connect the air conditioner to the power and position excess cord length beneath the air conditioner base.
3. Engage the chassis fixing brackets into the bottom housing rail and secure to the base with the screw provided.
4. Remove the front panel from its carton and plastic bag and fit as per the Installation Instruction.
5. Switch unit on. Check for operation of the unit and check for vibration in the installation.
6. Fit the drain pan to the housing and run a drain line to a suitable location if required.

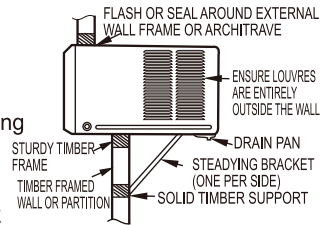

Alternative method of installation if external support cannot be provided.

## Installations of the unit into the wall

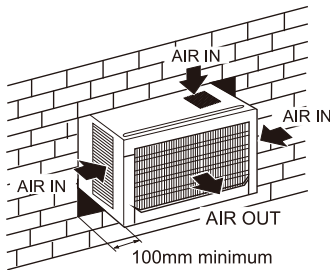

**OPTION A**

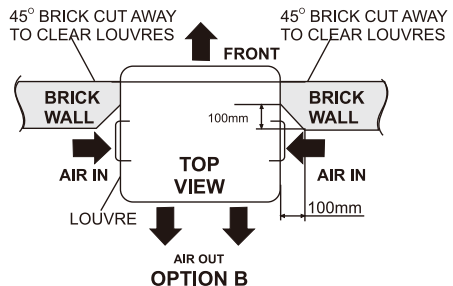

**OPTION B**

## Installation Steps

### Step 1. Remove the front panel and the air filter

1. Hold the slot under the front panel, then uplift it outwards, and remove the front panel (See Fig.1).
2. Pinch the handle under the air filter and make the air filter arched, remove it from the slot from underside to upside (See Fig.2).

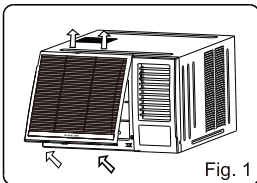

Fig. 1

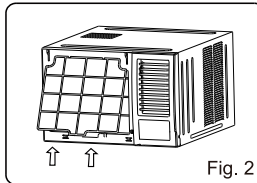

Fig. 2

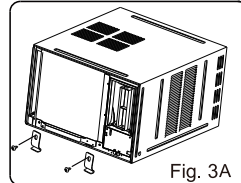

Fig. 3A

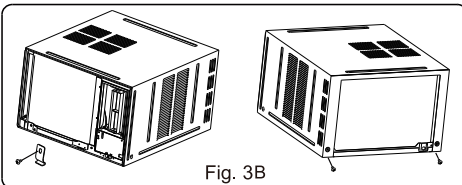

Fig. 3B

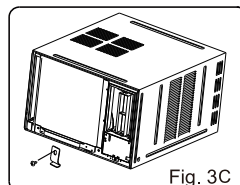

Fig. 3C

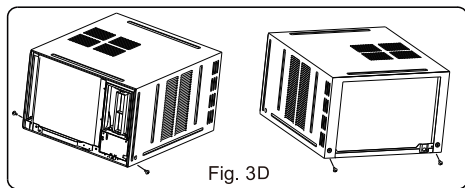

Fig. 3D

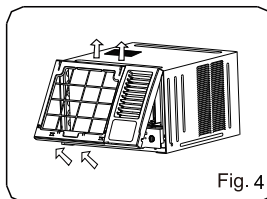

Fig. 4

### Step 2. Remove the frame.

- To meet different requirement of different type of air conditioner, there are four kinds of removing the frame.
  - Remove the two screws on the left and right chassis fixing brackets, then remove the two chassis fixing brackets as shown in Fig.3A.
  - Remove one screw on the chassis fixing bracket, then remove the chassis fixing bracket. Remove the two screws located on the back of the cabinet as shown in Fig.3B.
  - Remove one screw on the chassis fixing bracket, then remove the chassis fixing bracket as shown in Fig.3C.
  - Remove the four screws located on both sides and the back of the cabinet as shown in Fig.3D.
- Grasp the left corner int the frame's underside, then loosen the frame (See Fig.4).

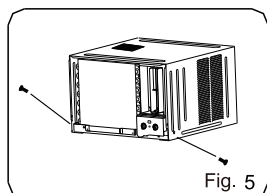

Fig. 5

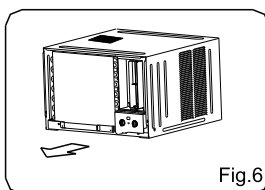

Fig.6

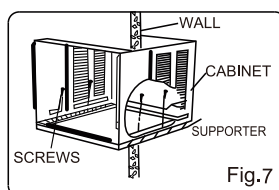

Fig.7

### Step 3. Installation.

- Remove the screws fix the chassis-fixing board and cabinet. some Models have two more screws on the back of the cabinet. (see Fig.5)
- Grasp the handle on the chassis and carefully slide the air conditioner out of the cabinet. (See Fig.6)
- When need to drain off water, intall the drain plug on the Chassis board. Then fix the cabinet on the supporter (provide for yourself or contact the dealer)(see Fig.7).
- Push the unit chassis into the cabinet. (see Fig.8)
- Fix the chassis and cabinet. (see Fig.5)

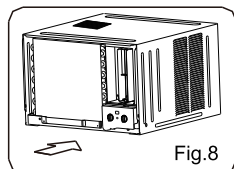

Fig.8

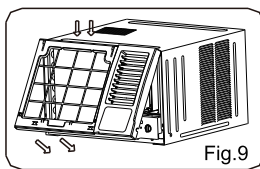

Fig.9

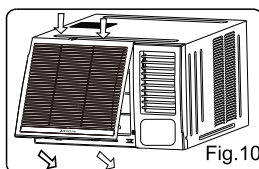

Fig.10

### Step 4. Install the frame.

- Install the frame. (See Fig.9).
- Fix the screws on the frame (See Fig.3A,3B,3C,3D).

### Step 5. Install the air filter and front panel.

- Install the air filter into the frame's slot from upside to underside (See Fig.2).
- Hang the front panel on the frame's buckle, then press the front panel into the frame's slot until you hear a click (See Fig.10).

## TROUBLESHOOTING

Before calling for service, review this list. It may save you time and expense. This list includes common occurrences that are not the result of defective workman-ship or materials in this appliance.

<b>Problem</b>	<b>Solution</b>
<b>Air conditioner does not start</b>	<i>Wall plug disconnected. Push plug firmly into wall outlet.</i>
	<i>House fuse blown or circuit breaker tripped. Replace fuse with time delay type or reset circuit breaker.</i>
	<i>Selector Control in OFF position. Turn selector to the desired FAN or COOL setting.</i>
	<i>Unit turned off by moving thermostat to a higher number and then immediately turning back to a colder number. Wait approximately 3 minutes. Listen for compressor to start.</i>
	<i>Unit turned off and then on too quickly. Turn unit off and wait 3 minutes before restarting.</i>
<b>Air from unit does not feel cold enough</b>	<i>Thermostat set too low. Adjust thermostat to higher number for cooling.</i>
	<i>Turn selector to a higher COOL position.</i>
	<i>Thermostat set too warm. Set thermostat to colder temperature.</i>
	<i>Room temperature below 18°C(64°F). Cooling may not occur until room temperature rises above 18°C(64°F).</i>
	<i>Temperature sensing tube touching cold coil, located behind air filter. Straighten tube away from coil.</i>
<b>Air conditioner cooling, but room is too warm- ice forming on cooling coil behind decorative front.</b>	<i>Outdoor temperature below 18 C(64 F). To defrost the coil, set selector to FAN position. Then, set thermostat to warmer position.</i>
	<i>Air filter may be dirty. Clean filter. Refer to Care and Cleaning section. To defrost, set selector to FAN.</i>
	<i>Thermostat set too cold for night-time cooling. To defrost the coil, set selector to a FAN position. Then, set thermostat to a warmer position.</i>
<b>Air conditioner cooling, but room is too warm- NO ice forming on cooling coil behind decorative front.</b>	<i>Dirty air filter- air restricted. Clean air filter. Refer to Care and Cleaning section.</i>
	<i>Thermostat set too warm. Turn thermostat clockwise to a colder setting.</i>
	<i>Air directional louvers positioned improperly. Position louvers for better air distribution.</i>
	<i>Front of units is blocked by drapes, blinds, furniture, etc. - restricts air distribution. Clear blockage in front of unit.</i>
	<i>Doors, windows, registers, etc. Open- cold air escapes. Close doors, windows, registers.</i>
	<i>Unit recently turned on in hot room. Allow additional time to remove Stored heat from walls, ceiling, floor and furniture.</i>
<b>Air conditioner turns on and off rapidly</b>	<i>Dirty air filter- air restricted. Clean air filter.</i>
	<i>Outside temperature extremely hot. Set to high cool to bring air past cooling coils more frequently.</i>
<b>Noise when unit is cooling</b>	<i>Air movement sound. This is normal . If too loud, turn selector to lower FAN setting.</i>
	<i>Sound of fan hitting water-moisture removal system. This is normal when humidity is high. Close doors, windows and registers.</i>
	<i>Window vibration - poor installation. Refer to installation instructions or check with installer.</i>
<b>Water dripping INSIDE when unit is cooling.</b>	<i>Improper installation. Tilt air conditioner slightly to the outside to allow water drainage. Refer to installation instructions - check with installer.</i>
<b>Water dripping OUTSIDE when unit is cooling.</b>	<i>Unit removing large quantity of moisture from humid room. This is normal during excessively humid days.</i>

# SPECIFICATIONS

## Unit dimensions:

MODEL (Btu/h)	BODY DIMENSION(mm) (W X H X D)
7000~9000	450X346X535
	450X346X585
9000~12000	560X400X640
	600X380X560
15000~16000	660X434X620
15000~24000	660X428X680
	660X428X780

**NOTE:** Value of D is for reference only.

## Minimum nominal cross-sectional area of conductors:

Rated current of appliance(A)	Nominal cross-sectional area(mm <sup>2</sup> )
3 and 6	0.75
6 and 10	1
10 and 16	1.5
16 and 25	2.5

## Suggest Minimum Wire Size(AWG:American Wire Gage):

Appliance Amps	AWG Wire Size
10	18
13	16
18	14
25	12
30	10

Toolbox Customer Service Centre :  
 Service E-mail: 8210service@gilman-group.com  
 Please register now at: www.toolbox.hk  
 Website: www.gilman-group.com

在本手冊內，您會發現許多有關如何正確使用和維護空調器的有用提示。您只要做一點預防性護理，就能在空調器的使用壽命期節省大量的時間和金錢。在故障排除提示表中，您可以找到許多常見問題的答案。如果您先查看我們的故障排除提示表，您可能不需要致電尋求服務。

### 注意

8歲及以上的兒童和身體、感官或心理能力下降或缺乏經驗和知識的人可使用本空調器，前提是他們已接受有關安全使用本空調器的監督或指導，並了解所涉及的危險。兒童不得玩耍本空調器。未經監督，兒童不得進行清潔和用戶保養。（適用於歐洲國家）

本空調器不適用於身體、感官或精神能力下降或缺乏經驗和知識的人員（包括兒童），除非他們已經由負責其安全的人員對空調器的使用進行了監督或指導。（適用於歐洲以外其他國家）

應監督兒童以確保他們不玩耍本空調器。

如果電源線損壞，必須由製造商、授權的維修中心或合資格人士更換，以避免危險。

空調器的安裝應符合國家鋪線規定。

不得在潮濕的房間（如浴室或洗衣間）操作空調器。

帶電加熱器的空調器與可燃物之間至少有1米的空間。

聯繫授權維修技術人員維修或保養本空調器。

聯繫授權安裝人員安裝本空調器。

如果“用戶使用說明書”和“遙控器使用說明書”功能說明之間有很大差異，應以“用戶使用說明書”的描述為準。

如果空調器在使用過程中被撞倒，立即關閉空調器並將其從主電源上拔下。檢查空調器，以確保沒有損壞。如果懷疑空調器損壞，聯繫技術人員或維修中心尋求幫助。

在雷暴期間，必須切斷電源，以免雷擊損壞機器。

為了減少火災或觸電的風險，請不要使用任何電晶體控速裝置控制該風扇。

不得在地毯下鋪設電源線。不得用地毯、家飾布或類似的覆蓋物覆蓋電源線。

不得在傢具或電器下面鋪設電源線。將電源線鋪設在遠離公共區域的地方以避免有人被絆倒。

## 目錄

安全注意事項 .....	20
產品零件介紹 .....	23
操作說明 .....	25
安裝說明 .....	28
疑難小百科 .....	31
技術參數 .....	32

## 閱讀本使用說明書

本使用說明書提供了許多有關冷氣機正確使用與維護的實用提示。祇要稍加注意，就能延長冷氣機的使用壽命。在疑難小百科中，您可以找到許多常見問題的解法方法。聯絡維修中心前，請先瀏覽疑難小百科。



### 注意

- 請聯絡授權的技術人員進行維修或保養本產品。
- 請聯絡授權的技術人員安裝本產品。
- 除非有安全人員的指導或協助下，並確保使用者的安全，否則此冷氣機不可由兒童、精神病人、殘疾人士及反應過慢之人士使用。
- 切勿讓兒童把玩冷氣機。
- 電源線祇能由廠方授權的技術人員或同符合資格的技术人員進行更換，以免發生意外。
- 清潔或保養前，請先關掉電源與供電斷路器。

# 安全注意事項

為避免造成任何人身傷害以及財產損失，請遵守以下指引。

■ 本使用說明書所使用符號的含義如下：

	<b>切勿執行</b>
	<b>必須執行</b>

## 警告

可能造成死亡或者嚴重傷害

- |   |   |  |
|---|---|--|
| <p>Ⓢ 電源綫不可靠近可燃氣體或易燃物，如汽油、苯、稀釋劑等</p> <ul style="list-style-type: none"> <li>● 否則可能導致爆炸或火災</li> </ul>   | <p>Ⓢ 當冷氣機運行時，請關上門窗。</p> <ul style="list-style-type: none"> <li>● 否則會影響製冷效果</li> </ul> | <p>Ⓢ 不可損壞電源綫或使用不符合規格的電源綫</p> <ul style="list-style-type: none"> <li>● 否則會導致觸電或火災</li> <li>● 如果電源綫已經損壞，必須由製造商、已經授權的維修中心或者合資格的人士進行更換，以免造成危險</li> </ul> |
| <p>Ⓢ 不可更改電源綫長度或與其他電器共用插座</p> <ul style="list-style-type: none"> <li>● 否則會因為過熱而導致觸電或火災</li> </ul>      | <p>Ⓢ 手未擦乾不可操作冷氣機</p> <ul style="list-style-type: none"> <li>● 否則會觸電</li> </ul>        | <p>Ⓢ 送風口不要直接對着房間內的人</p> <ul style="list-style-type: none"> <li>● 否則會有損健康</li> </ul>  |
| <p>Ⓢ 請必須確定接地妥當</p> <ul style="list-style-type: none"> <li>● 接地不當可能會導致觸電</li> </ul>                    | <p>Ⓢ 不要弄濕帶電部分</p> <ul style="list-style-type: none"> <li>● 否則可能引起空調故障或觸電</li> </ul>   | <p>Ⓢ 務必安裝斷路器以及專門的電源電路</p> <ul style="list-style-type: none"> <li>● 安裝不當會導致火災或觸電</li> </ul>   |
| <p>Ⓢ 如果冷氣機出現怪聲、異味或冒煙，請立即斷電</p> <ul style="list-style-type: none"> <li>● 否則可能導致火災或觸電</li> </ul>        | <p>Ⓢ 電源綫不可靠近熱源</p> <ul style="list-style-type: none"> <li>● 否則可能導致火災或觸電</li> </ul>    | <p>Ⓢ 冷氣機運轉時不要打開機身</p> <ul style="list-style-type: none"> <li>● 否則可能觸電</li> </ul>   |
| <p>Ⓢ 如果曾經出現煤氣泄漏，使用冷氣前請先對房間進行通風</p> <ul style="list-style-type: none"> <li>● 否則可能導致爆炸、火災或燒傷</li> </ul> | <p>Ⓢ 不可拆卸或改裝冷氣機</p> <ul style="list-style-type: none"> <li>● 否則可能導致故障或觸電</li> </ul>   |  |



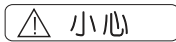

可能造成傷害或財產損失

⊖ 拆除冷氣濾塵網時，不要接觸冷氣機的金屬部分

- 否則會受傷

⊖ 不要用水清洗冷氣機內部

- 如果有水進入冷氣機，會影響絕緣功能，可能導致觸電

⓪ 當與暖爐等一起使用時，要保持房間通風良好

- 否則會出現缺氧

⓪ 清潔或維修冷氣機前，要關掉電源，並關閉斷路器

- 通電時不要清潔冷氣機，否則可能導致火災或觸電，造成人身傷害

⊖ 不要把寵物或植物正對送風口

- 否則會對寵物或植物造成傷害

⊖ 不要利用冷氣機來保護精密儀器、保存食品、照顧寵物與植物、保管藝術品等

- 否則可能造成財物受損。

⓪ 狂風暴雨時請關掉冷氣機，並關閉窗戶

- 此時打開窗戶會導致室內潮濕，並讓家具受潮

⓪ 不要飲用冷氣機冷凝水

- 水中含有雜質，會使人生病

⓪ 長期不使用冷氣機時請關掉主電源開關

- 否則可能導致產品故障或火災

⊖ 不要在進氣口附近或排氣口內部放置任何物件

- 否則會導致冷氣機故障或意外

⓪ 確保放於室外的安裝架不會因為長期外露而受損

- 如果安裝架受損，冷氣機可能墜下，造成破壞

⓪ 務必固定好濾塵網，每兩周清潔一次

- 不加濾塵網運轉，可能導致故障

⊖ 不要使用稀釋劑等強力清潔劑，祇能使用乾布

- 可能會導致冷氣機褪色、表面被刮花，破壞外觀

⊖ 不要在電源線上放置任何物品，確保電源線沒有被擠壓

- 否則有火災或觸電危險

⓪ 開箱及安裝時必須小心，鋒利邊緣容易造成傷害

⓪ 如果冷氣機進水，請馬上關閉冷氣機及斷路器。拔出電源插頭，並符合資格的維修技術人員聯絡

## 安全注意事項

### 操作前準備

1. 聯絡專門的技術人員進行安裝。
2. 不要使用破損或不符合標準的電源綫。
3. 不要與其他電器共用插座。
4. 請不要與其他設備共用出風口。
5. 請勿使用外延電源綫。
6. 請勿通過拔插電源綫的方式開關機。

### 使用

1. 長時間直接對着送風口會有損健康。不要讓任何人、寵物或植物長時間直接對着送風口。
2. 與暖爐或其他製熱設備一同使用時，請保持室內通風，以免氧氣不足。
3. 不可將冷氣機用作其他用途（例如保護精密儀器、保存食品、寵物與植物、保護藝術品等），否則有可能造成財物損失。

### 清潔與保養

1. 拆除濾塵網時不要接觸冷氣機的金屬部分及注意鋒利的金屬邊緣，以免受傷。
2. 不要用水清洗冷氣機內部。有水進入冷氣機會影響絕緣，可能導致觸電。
3. 清潔或保養前，首先關掉電源與供電斷路器。

### 運行環境溫度

製冷操作	室外溫度	18-43 °C
	室內溫度	17-32 °C
	<b>注意：</b> 室內的相對濕度應小於80%。如果冷氣機使用環境的相對濕度大於80%，冷氣機表面就會出現冷凝水。	

如果冷氣機的操作條件不符合上述要求，冷氣機可能會出現故障。

注意：在安裝前，請移除包裝箱裏的全部包裝材料，沿着機器側面的格柵移除運輸固定用的擋塊。

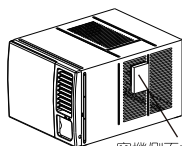

窗機側面格柵處用于包裝固定機身的擋塊

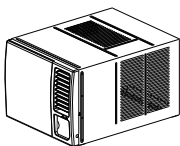

請移除窗機側面格柵處用于包裝固定機身的擋塊

## 產品零件介紹

注：面板及外箱會根據不同型號而有所不同，但功能均一樣，以下圖解祇作解析用途，實際外形或有所不同。

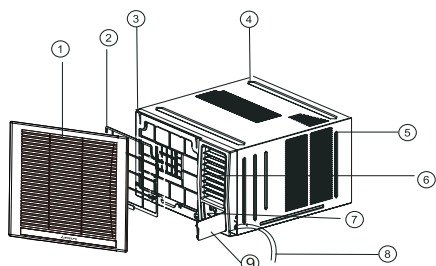

1. 面板
2. 濾塵網
3. 面框
4. 外箱
5. 進風格柵（室外側）
6. 送風口
7. 控制面板
8. 電源綫
9. 控制面板開關門

## 附件

排水塞



1

密封圈



1

接水盤



1

螺釘



2 ( ≤ 12000Btu )

4 ( ≥ 18000Btu )

注：

1. 電源綫的顏色如下所示（見圖1）。
2. 如需更換電源綫，請與製造商、其維修代理商或相關合資格的專業人士聯絡。
3. 爲確保安全，冷氣機已通過電源綫接地。確保冷氣機接地妥當。牆壁插座（開關）必須配有可靠的地綫（見圖2）。
4. 冷氣機應配有獨立電路，斷路器及保險絲的額定值必須與電源綫及牆壁插座一致。

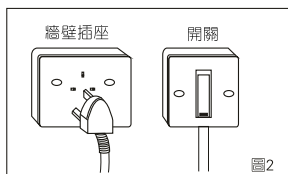
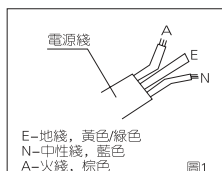

# 操作說明

## 控制面板

冷氣機的控制面板與下圖所示相似：

機型 7200~8800Btu/h

機型 12000~18000Btu/h

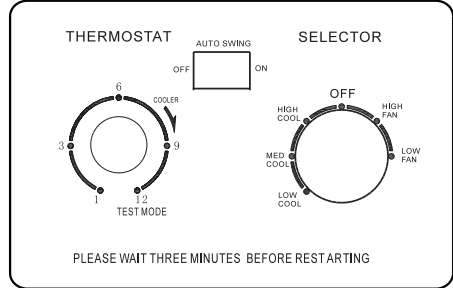
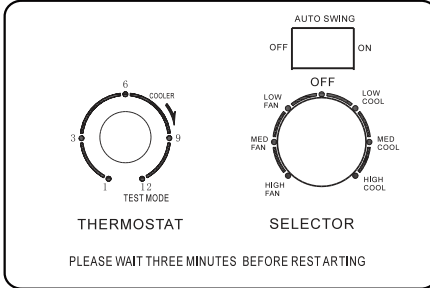

注：以上控制面板的外觀是以標準機型為基礎，可能與實物外觀有不同之處，但按鍵功能是一致的，各型號的選擇旋鈕會以下圖所示說明為準。

## 選擇旋鈕

### SELECTOR

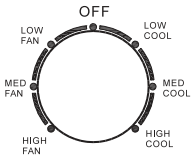

機型 7200~12000Btu/h

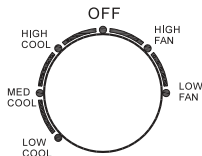

機型 18000Btu/h

### 製冷模式

把旋鈕向左轉到相應的位置，即可得到所需的製冷模式。

“HIGH COOL”指冷氣機快速製冷並送出強風。

“MED COOL”指冷氣機處於中冷運行狀態並送出中風。

“LOW COOL”指冷氣機處於低冷運行狀態並送出弱風。

“OFF”指冷氣機關閉。

### 送風模式

(HIGH FAN(高風), MED FAN(中風), LOW FAN(低風))

把旋鈕轉到所需的送風速度。

注：1. 選擇送風速度時，壓縮機不會運轉。

2. 把選擇旋鈕從“低冷”轉到“高冷”時，速度要盡量放慢。不要經常在“低冷”與“高冷”的操作模式下切換。

## 操作說明

### 溫控器

## THERMOSTAT

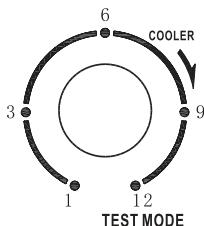

### 溫控器

冷氣機在“製冷模式”下運行時，溫控器可用於設定所需的房間溫度。

把溫控器的旋鈕旋轉到相應的位置，即可設定所需的房間溫度。在達到設定溫度後，溫控器將自動開啓，而壓縮機將停止，以維持所需的設定溫度。

順時針旋轉溫控器旋鈕，選擇較高的製冷設定。較高的製冷設定可以提供相應低的房間溫度。

逆時針旋轉溫控器旋鈕，選擇較低的製冷設定。較低的製冷設定可以提供相應高的房間溫度。

### 注：

1. 在冷氣機製冷運行期間，旋轉溫控器旋鈕調節溫度後，必須等待最少三分鐘後方可再調節溫度，否則保險絲可能會因為冷氣機過載而斷掉。
2. 9-12區間為低溫運行區域，12為測試模式。  
注意：測試模式祇供廠方測試用途，切勿選擇該區，可能會引至蒸發器結霜。  
請勿於正常運作下選擇測試模式！

### 自動搖擺

水平送風調節（自動）

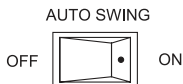
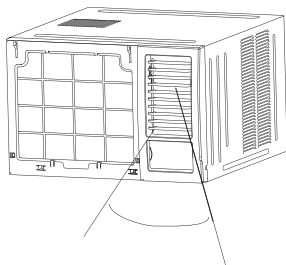

當“**AUTO SWING(自動搖擺)**”轉到“**ON(開)**”的位置時，垂直導風葉片會自動左右擺動，吹送冷空氣以達到舒適的製冷效果。當“**自動搖擺**”轉到“**OFF(關)**”的位置時，垂直導風葉片就會馬上停止擺動。

## 通風控制

通風撥杆位於控制面板的上方。操作方法根據不同型號而異（見下圖）。

在製冷狀態下，通常將撥杆設定在“CLOSE(關)”的位置，以獲得最大的製冷效果。如果室內空氣不流通，可將撥杆設定在“OPEN(開)”的位置，這樣可將室內混濁空氣排出。

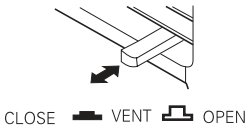

把撥杆拉出即可打開通風。  
將其推入可關閉通風。

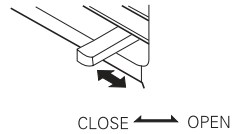

把撥杆推向右側即可打開通風。  
將其推向左側可關閉通風。

## 手動垂直送風調節

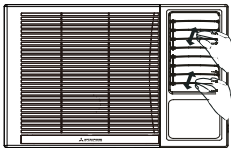

要調節垂直送風的方向，祇需調節任何一扇水平的導風葉片。調節水平葉片時，務必使最上方或最下方的葉片保持水平。這可避免冷凝水滴在主機的面板上。

## 濾塵網

進風格柵後的濾塵網必須每隔兩周（或根據需要）進行檢查與清潔，以確保冷氣機的最佳性能。

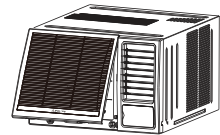

注意



在沒有安裝濾塵網之前，不能開啓冷氣機，  
塵埃或污垢粒子會損害冷氣機設備。

## 濾塵網

### 如何拆除濾塵網

1. 握住面板下方的狹槽，然後將其向外提起，抬起面板。
2. 捏緊濾塵網下方的把手，使濾塵網拱出，由下往上將其從狹槽取出。
3. 用溫水清潔濾塵網，水溫應在40°C 以下，以免濾塵網變形。
4. 把濾塵網上的水擦乾，並輕輕甩動。等濾塵網完全乾燥後再重新裝回。不要把濾塵網直接放在陽光下曬乾，以免變形。

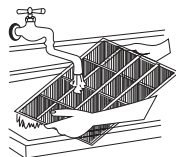
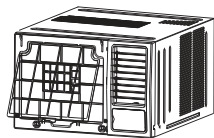

## 冷凝水的處理

根據不同類型冷氣機的相關要求，冷凝水的處理方法有兩種。

後部排水的步驟如下：

1. 將排水接頭套上密封圈（與冷氣機附件一同提供）。
2. 把冷氣機後部排水孔的膠塞取出，然後塞到下部的排水孔。
3. 把排水接頭安裝在原來膠塞的位置，旋轉90°加以固定。
4. 在排水接頭上裝上延長排水管。

後部排水

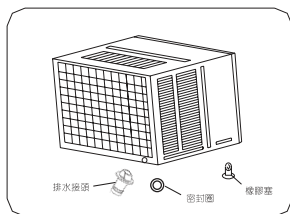

下部排水的步驟如下：

1. 將底盤的排水孔的膠塞取出，然後塞到後側的排水孔。
2. 取出接水盤和固定螺釘（與冷氣機附件一同提供）。
3. 將接水盤安裝在底盤位置，並用螺釘固定好。
4. 在排水接頭上裝上延長排水管（自行購買）。

建議：為確保冷凝水從水喉流出流暢，當安裝接水盤時，要保持接水盤向下降。

下部排水

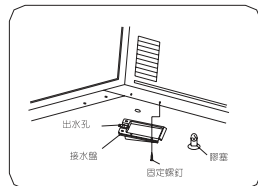

（注意：如果選擇不要去水，應用膠塞插入下部、後部去水孔。）

## 安裝說明

### 選擇最佳的位置

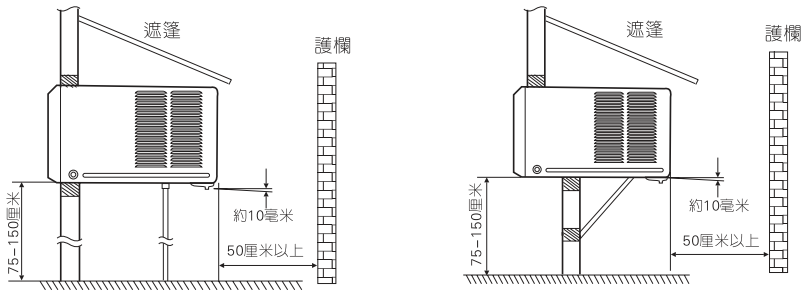

1. 避免振動與噪音，冷氣機安裝時必須穩固。
2. 把冷氣機安裝在陽光不能直接照射的地方。  
如果要安裝在陽光直接照射的地方，可建造遮篷保護外箱。
3. 外箱後部50厘米範圍內不能有護欄或牆壁等障礙物，否則會影響冷凝器散熱。  
若外部空氣受阻，將大大影響冷氣機的製冷性能。
4. 安裝冷氣機時稍微向外傾斜，不要讓冷凝水流入室內（與水平面相差10毫米的距離）。
5. 安裝冷氣機時，其底部與地面應相隔75~150厘米。
6. 電源線應連接到獨立的電路。黃色/綠色的電線必須接地。

#### 注意

- \* 外箱各個側面的格柵都必須露在外面。
- \* 安裝本產品須按照當地的安裝佈線規則。



## 安裝外箱

### 第一步

把冷氣機從包裝箱內取出，取下固定螺釘，然後把冷氣機從外箱中滑出（參考安裝步驟）。

### 第二步

在牆上鑽孔，以使外箱得到良好支撐，外牆的開孔應密封。外箱應往後傾斜約10毫米，以便排放操作過程中產生的冷凝水。

### 第三步

把外箱安裝在牆壁內並固定好。確保軟膠密封件完好。把內部與外部的空隙焊接、密封或填好，以使外表美觀，並能防止風雨侵蝕及蟲鼠破壞。

注：冷氣機可在下方以牢固的機框支撐，或者在上方通過結實的支架進行支撐。

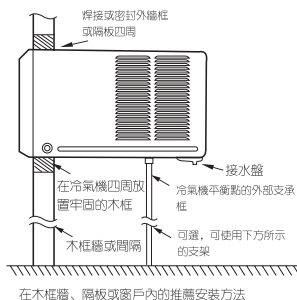

## 把冷氣機安裝到外箱內

1. 把冷氣機推入外箱內，直到緊靠外箱後部。必須確保外箱上的軟膠密封條保持原位。
2. 連接冷氣機電源，在冷氣機底部預留較長的電綫。
3. 把底部固定架嵌入外箱底部導軌內，並利用螺絲將其固定到底座上。
4. 把面板從箱子和塑料袋中取出，根據安裝指引進行裝配。
5. 打開冷氣機，檢查其操作，並檢查安裝時是否有振動。
6. 把接水盤安裝到外箱上，根據需要把排水管放置到合適的地方。

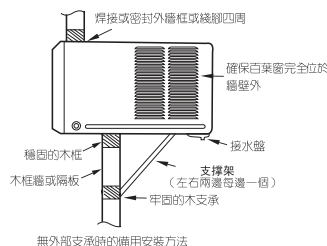

## 把冷氣機安裝到牆壁上

牆壁與外箱或進風格柵的最小距離：

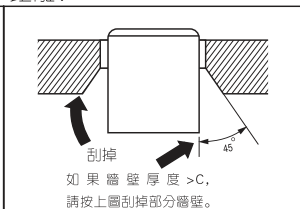
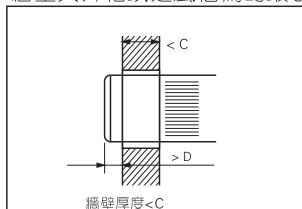

	尺寸(毫米)
A	200*
B	500
C	210
D	60

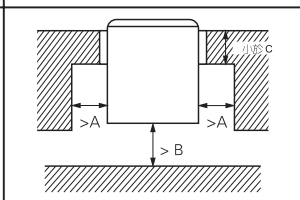
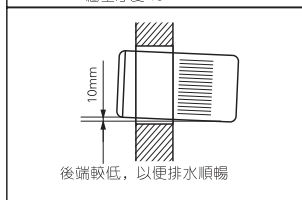

\* A位置需根據不同機型及安裝環境而定，但安裝距離不小於200毫米。

## 安裝步驟

### 第一步 拆除面板和空氣濾塵網

1. 握住面板下方的狹槽，然後將其向外提起，取出面板（見圖1）。
2. 捏緊空氣濾塵網下方的把手，使濾塵網拱出，由下往上將其從狹槽取出（見圖2）。

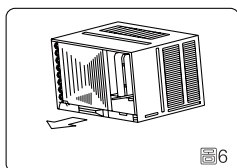
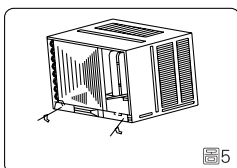
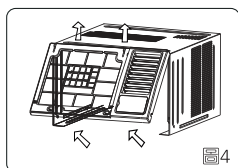
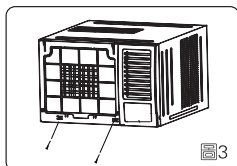
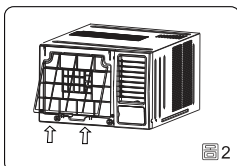
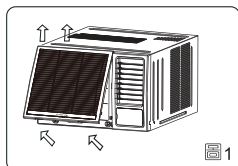

### 第二步 拆卸面框

1. 取出面框前面的兩顆固定螺釘（見圖3）。
2. 抓住面框左下角，鬆開對接插頭，然後鬆開面框（見圖4）。

### 第三步 安裝

1. 取出底盤固定板上的兩顆固定螺釘，然後拆下底部固定板（見圖5）。
2. 拉緊底盤上的把手，小心將冷氣機從外箱中拉出（見圖6）。
3. 操作前先把壓縮機周圍的外包裝材料取走，把底盤推入外箱前，確保排水嘴對準接水盤（見圖7）。
4. 把冷氣機底盤推入外箱（見圖8）。
5. 利用兩顆固定螺釘安裝兩個底盤固定板（見圖5）。

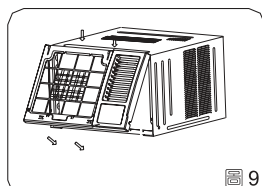
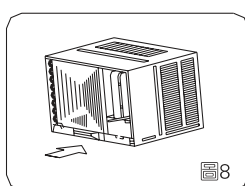
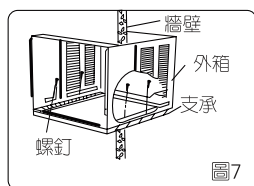

### 第四步 安裝面框

1. 安裝面框，連接好對接插頭，確保不會阻礙溫度傳感器電纜（見圖9）。
2. 在面框擰上螺釘（見圖3）。

### 第五步 安裝濾塵網和面板

1. 將濾塵網先上後下裝入面框上的固定卡槽內（見圖2）。
2. 把面板掛在面框的扣位內，然後把面板按入機框狹槽內，直到聽到咔嚓一聲為止（見圖10）。

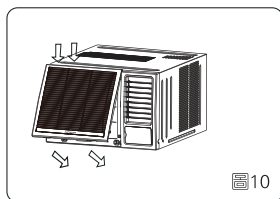

聯絡維修中心前請先看看下表。

## 一般操作

- 在雨天或者濕度較高時，由於積水滴在冷凝器上，或許會聽到一些的聲音。
- 壓縮機不斷循環時，或許會聽到溫控器的咔嚓聲。
- 在濕度較高或雨天，底盤上會出現積水。積水過多時就會由室外側流出。
- 壓縮機停止循環時，風扇可能會繼續運轉。

問題	可能原因	處理方法
冷氣機不能啟動	■ 冷氣機插頭沒有插好。	● 確保冷氣機的插頭已經插好。
	■ 保險絲斷了或者斷路器跳閘。	● 檢查房屋的保險絲或斷路器，更換保險絲或復位斷路器。
	■ 電路故障	● 如果出現電路故障，請關掉冷氣機，拔下插頭。電力恢復後，重新連接插頭，打開電源，等3分鐘再重新啟動冷氣機，避免壓縮機過載而跳閘。
冷氣機製冷不夠	■ 氣流受阻	● 確保冷氣機沒被窗簾、百葉窗或家具等阻擋。
	■ 濾層網變髒	● 至少每兩周清潔一次濾網。請參考操作說明的部分。
	■ 房間內溫度過高	● 如果冷氣機剛開，需要一定時間才能降低房間溫度。
	■ 冷空氣外溢	● 檢查爐底的通風裝置是否打開，使得冷空氣回流。 ● 把冷氣機的通風口設定到關閉為止。
	■ 蒸發器結冰	● 參考下面的“冷氣機結冰”。
冷氣機結冰	■ 冰塊阻礙氣流，冷氣機不能使房間降溫。	● 把風速設定到“中風”或“高風”，直到冰塊融化。

## 技術參數

機型 (Btu/h)	機身大小 (毫米) (寬×高×深)	配綫規格 (平方毫米)
≤9000	450×346×585	≥3*1.0
> 9000 及 ≤12000	600×380×560	≥3*1.5
≥18000	660×428×680	≥3*2.5

客戶服務中心:

電郵地址: [8210service@gilman-group.com](mailto:8210service@gilman-group.com)

請即上網登記: [www.toolbox.hk](http://www.toolbox.hk)

網址: [www.gilman-group.com](http://www.gilman-group.com)



 **MITSUBISHI HEAVY INDUSTRIES**

---