

# 空調器使用說明書

## 三菱重工窗口式空調器

中文

ENGLISH

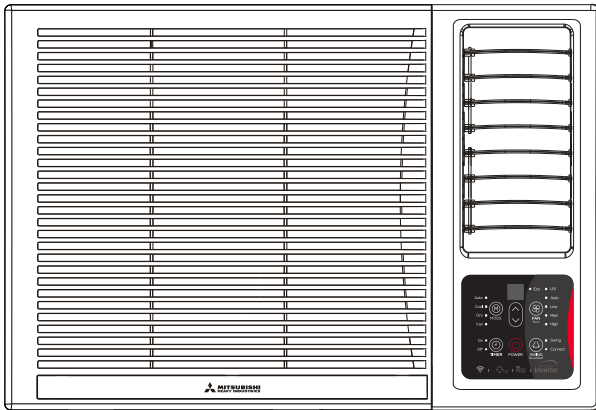

### USER'S MANUAL

WRK20MGC1  
WRK26MGC1  
WRK35MGC1  
WRK53MGC1

R32 Refrigerant



承蒙選購三菱重工空調器，深表感謝！爲了使空調器長久保持其良好的運轉性能，在您開始使用空調器之前，務請仔細閱讀本說明書。閱後應將它妥善保管好，以備必要時查閱。

Thank you for purchasing a MITSUBISHI HEAVY INDUSTRIES-JINLING AIR CONDITIONERS CO.LTD. Air-Conditioner. To get the best long-lasting performance, please read and follow this User's Manual carefully before using your air-conditioner. After reading, please store the Manual in a safe place and refer to it for operational questions or in the event of any irregularities.

本空調器使用輕度易燃製冷劑(R32)，當需要維修、檢查以及保養時，請對經銷商說明此情況。

This air conditioner uses mildly flammable refrigerant(R32). Please explain this to dealer when it needs repair, inspection and maintenance.

本空調器適用於家用。

This air-conditioner is intended for domestic use.

# 安全須知

操作和安裝前請閱讀安全須知

由於忽視說明而導致錯誤安裝可能會產生嚴重的損壞或傷害。



## 1. 安裝 (空間)

- 製冷劑管道應符合國家氣體法規。
- 機械連接應便於維護。
- 在需要機械通風的情況下，通風口應保持暢通無阻。
- 處理使用過的產品時，應根據國家規定妥善處理。





## 2. 維修

- 任何操作或拆解製冷劑回路的人員都必須持有行業認可的評估機構頒發的有效證書，該證書授權其根據行業認可的評估規範安全處理製冷劑。
3. 維護和修理需要其他技術人員的協助，應在有能力使用易燃製冷劑的人員監督下進行。
  4. 除廠家推薦的方法外，請勿使用任何其他方法加速除霜過程或進行清潔。
  5. 電器應存放在沒有持續工作的點火源的房間內（例如：明火、工作的燃氣器具或電加熱器）。
  6. 請勿讓異物（油、水等）進入配管。此外，在保管配管時，請通過夾緊、膠帶等將開口密封好。
  7. 請勿刺穿或燃燒。
  8. 請注意，製冷劑可能沒有氣味。
  9. 所有影響安全措施的工作程式只能由合格人員進行。
  10. 電器應存放在通風良好的區域，房間大小應與具體操作面積相符。
  11. 存放電器時應防止發生機械損壞。
  12. 電器使用輕度易燃製冷劑R32，並經測試符合IEC 60335-2-40。電器沒有最小房間面積要求。
  13. 安裝高度不得低於0.75米。

## 裝置運輸、標記和儲存

1. 含有易燃製冷劑的設備的運輸  
遵守運輸法規
2. 使用標誌標記設備  
遵守當地法規
3. 使用易燃製冷劑的設備的處置  
遵守國家法規
4. 設備/電器的存放  
設備的儲存應按照製造商的說明進行。
5. 已包裝（未售出）設備的存放  
儲存包裝保護裝置的結構應確保包裝內的設備發生機械損壞時不會導致製冷劑洩漏。  
允許存放在一起的最大設備件數根據當地法規確定。

## 本機顯示符號的說明

	警告	此符號表示此設備使用輕度易燃製冷劑。如果製冷劑洩漏並暴露於外部火源，則有著火的風險。
	小心	此符號表示應細閱讀使用說明書。
	小心	此符號表示維修人員應參考安裝手冊處理此設備。
	小心	此符號表示使用說明書或安裝手冊提供相關資訊。

# 目錄

警告 .....	03
裝置部件識別 .....	09
操作說明 .....	10
保養和維護 .....	11
排水 .....	12
安裝說明 .....	13
故障排除 .....	15
規格 .....	16

## 環境保護

2018年12月31日起，被棄置受管制電器處置管制、進出口管制及堆填區棄置禁令正式實施。任何人儲存、處理、再加工或循環再造被棄置受管制電器，均須取得廢物處置牌照；輸入及輸出被棄置受管制電器均須領有許可證。堆填區及其他指定廢物處置設施（例如廢物轉運站）則不會再接收和處置被棄置受管制電器。

# 警告

## 請在操作和安裝前閱讀

由於忽視說明而導致錯誤安裝可能會產生嚴重的損壞或傷害。潛在損壞或傷害的嚴重性分為警告或小心。



### 警告

此符號表示可能造成人員受傷或死亡。



### 小心

此符號表示可能造成財產損失或嚴重後果。



### 警告

本電器可供身體、感官或精神能力有缺陷或缺乏經驗和知識的人員（包括兒童）使用，前提是有負責人員提供有關電器使用的監督或指導。應監督兒童以避免其玩耍本電器。



### 產品使用警告

- 本設備使用 R32 輕度易燃製冷劑。
- 如果出現異常情況（如燒焦味），請立即關閉電器並斷開電源。請致電您的經銷商獲取有關避免觸電、火災或人身傷害的指導。
- **請勿**將手指、杆或其他物體插入進風口或出風口，否則可能會導致人身傷害，因為風扇可能在高速旋轉。
- **請勿**在本機附近使用髮膠、油漆或塗料等易燃噴霧劑，否則可能會導致火災或燃燒。
- **請勿**在可燃氣體附近或周圍運行空調。散發的氣體可能會聚集在設備周圍並導致爆炸。
- **請勿**在浴室或洗衣房等潮濕的房間內使用空調。過多接觸水會導致電氣元件短路。
- **請勿**將身體長時間直接暴露在冷空氣中。
- **請勿**讓兒童玩耍空調。兒童在設備周圍時必須受到監督。
- 如果空調與燃燒器或其他加熱設備一起使用，請徹底通風，以免缺氧。
- 在某些功能環境中，如廚房、伺服器機房等，強烈建議使用專門設計的空調機組。
- 如果發出奇怪的聲音、氣味或煙霧，請拔下設備插頭或斷開電源。
- 為進一步優化設備性能，請在操作期間保持門窗關閉。
- 開箱安裝時要注意，鋒利的邊緣可能會造成傷害。

### 清潔和維護警告

- 清潔前關閉設備並斷開電源，否則可能會導致觸電。
- **請勿**使用過多的水清潔空調。
- **請勿**使用可燃清潔劑清潔空調，否則可能會引起火災或變形。



### 小心

- 如果長時間不使用，請關閉空調並斷開電源。
- 在暴風雨期間關閉並拔掉設備插頭。
- 確保冷凝水可以從設備中暢通無阻地排出。
- **請勿**用濕手操作空調，否則可能會導致觸電。
- **請勿**將設備用於預期用途以外的任何其他目的。
- **請勿**攀爬或在空調頂部放置物體。
- **請勿**讓空調長時間在門窗打開或者在濕度非常高的情況下運行。

## 電氣警告

- 僅使用指定的電源線。如果電源線損壞，必須由製造商、其服務代理商或類似的合格人員更換，以避免發生危險。
- 保持電源插頭清潔。清除積聚在插頭上或插頭周圍的任何灰塵或污垢。髒插頭會導致火災或觸電。
- **請勿**拉扯電源線以拔下設備插頭。請握住插頭並將其從插座中拔出。直接拉扯會損壞電源線，從而導致火災或觸電。
- **請勿**修改電源線的長度或使用延長線為設備供電。
- **請勿**與其他電器共用電源插座。電源供應不當或不足會導致火災或觸電。始終安裝斷路器和專用電源電路。
- 如果插座鬆動或損壞，**請勿**使用。
- **請勿**在電源線上放置重物，並確保電源線沒有被壓扁，否則有火災或觸電的危險。
- 如果水進入設備，請在電源插座處關閉設備並關閉斷路器。拔下電源插頭或斷開設備電源，並聯繫合格的維修技術人員。
- 產品安裝時必須正確接地，否則可能會發生觸電。
- 對於所有電氣工作，請遵循所有當地和國家接線標準、法規以及設備頂部面板上的電氣連接圖。
- 如果將電源連接到固定接線，應使用所有極間至少有3毫米間隙且漏電流可能超過10mA的全極斷開裝置，剩餘電流裝置（RCD）的額定剩餘工作電流不超過30mA，並且必須按照接線規則將斷開裝置包含在固定接線中。
- 本機通過電源線接地，確保裝置正確接地。壁式插座（空氣開關）應有可靠的地線。
- 設備應配備獨立電路，斷路器/保險絲額定值應與電源線和壁式插座的額定值相同。電源線導體根據顏色區分，如機器頂部的接線圖所示。

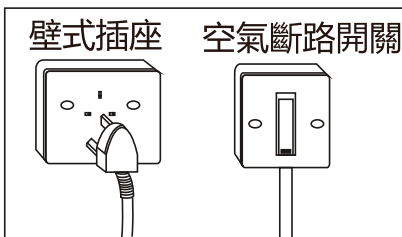

### 注意保險絲規格

空調的電路板（PCB）設計有保險絲以提供過流保護。電路板上印有保險絲的規格，如220V。

## 產品安裝警告

1. 安裝必須由授權經銷商或受過專業訓練人員進行。有缺陷的安裝會導致漏水、觸電或火災。
2. 安裝必須按照安裝說明進行。安裝不當會導致漏水、觸電或火災。（在北美，只能由授權人員按照NEC和CEC的要求進行安裝。）
3. 聯繫授權服務技術人員修理或維護本設備。本電器應按照國家接線規定進行安裝。
4. 只能使用附帶的附件、零件和指定的零件進行安裝。使用非標準部件會導致漏水、觸電、火災，並可能導致設備故障。
5. 將設備安裝在能夠支撐設備重量的穩固位置。如果選擇的位置不能支撐設備重量，或者安裝不當，設備可能會掉落並導致嚴重的人身傷害和損壞。
6. 按照本手冊中的說明安裝排水管道。排水不當可能會對您的房屋和財產造成損壞。
7. 對於帶有輔助電加熱器的裝置，請勿將裝置安裝在距離任何可燃材料1米（3英尺）的範圍內。
8. **請勿**將設備安裝在可能暴露於可燃氣體洩漏的位置。如果可燃氣體積聚在本機周圍，可能會引起火災。
9. 在所有工作完成之前**請勿**打開電源。
10. 移動或重新安置空調時，請諮詢有經驗的維修技術人員進行裝置的斷開和重新安裝。
11. 關於如何將電器安裝到支架上，請閱讀“安裝說明”部分的詳細資訊。

## 使用R32製冷劑的警告

- 除廠家推薦的方法外，請勿使用任何其他方法加速除霜過程或進行清潔。
- 電器應存放在沒有持續工作的點火源（例如：明火、工作的燃氣器具）的房間內，並且電器附近不得有火源（例如：工作的電加熱器）。
- 請勿刺穿或燃燒。
- 請注意，製冷劑可能沒有氣味。
- 應遵守國家氣體法規。
- 保持通風口暢通無阻。
- 妥善存放電器以防止發生機械損壞。
- 電器應存放在通風良好的區域，房間大小應與具體操作面積相符。
- 任何操作或拆解製冷劑回路的人員都必須持有行業認可的評估機構頒發的有效證書，該證書授權其根據行業認可的評估規範安全處理製冷劑。
- 維護和修理需要其他技術人員的協助，應在有能力使用易燃製冷劑的人員監督下進行。
- 請仔細按照說明操作、安裝、清理、維修空調，以免造成任何損壞或危險。空調使用可燃製冷劑R32。維修或處置空調時，應妥善回收製冷劑（R32），不得直接排放到空氣中。
- 空調周圍不得有任何明火或開關等可能產生火花/電弧的裝置，以免引起易燃製冷劑著火。請仔細按照說明存放或維護空調，以免發生機械損壞。
- 空調使用易燃製冷劑。請仔細按照說明進行操作，以免發生任何危險。



**警告：低燃速材料**  
(IEC 60335-2-40:2018適用於  
R32型號)



**重要說明：安裝或操作新空調機組之前請  
仔細閱讀本手冊。**

**本機顯示符號說明（僅適用於採用R32製冷劑的機組）：**

	警告	此符號表示此設備使用輕度易燃製冷劑。如果製冷劑洩漏並暴露於外部火源，則有著火的風險。		小心	此符號表示維修人員應參考安裝手冊處理此設備。
	小心	此符號表示應細閱讀使用說明書。		小心	此符號表示使用說明書或安裝手冊提供相關資訊。

**1. 含有易燃製冷劑的設備的運輸**

遵守運輸法規

**2. 使用標誌標記設備**

遵守當地法規

**3. 使用易燃製冷劑的設備的處置**

遵守國家法規

**4. 設備/電器的存放**

設備的儲存應按照製造商的說明進行。

**5. 已包裝（未售出）設備的存放**

儲存包裝保護裝置的結構應確保包裝內的設備發生機械損壞時不會導致製冷劑洩漏。允許存放在一起的最大設備件數根據當地法規確定。

**6. 維修資訊**

**1) 現場檢查**

在開始對含有易燃製冷劑的系統進行操作之前，必須進行安全檢查以確保將著火風險降至最低。對於製冷系統的維修，在對系統進行操作之前應遵守以下預防措施。

**2) 工作程式**

工作應在受控程式下進行，以最大程度地減少工作期間出現易燃氣體或蒸汽的風險。

**3) 一般工作區**

所有維修人員和在當地工作的其他人員都應瞭解所進行工作的性質。應避免在密閉空間內工作。工作區周圍的區域應分隔開。通過控制易燃材料，確保該區域內的狀況安全。

**4) 檢查是否有製冷劑**

在工作之前和工作期間，應使用適當的製冷劑檢測器檢查該區域，以確保技術人員瞭解潛在的易燃環境。確保所使用的洩漏檢測設備適用於易燃製冷劑，即無火花、充分密封或本質安全。

**5) 配備滅火器**

如果對製冷設備或任何相關部件進行任何熱加工，應準備好合適的滅火設備。在充注區附近放置一個乾粉或二氧化碳滅火器。

**6) 無火源**

任何人在可能暴露於含有或曾經含有易燃製冷劑的任何管道工程的製冷系統上執行操作時，不得以可能導致火災或爆炸風險的方式使用任何點火源。所有可能的火源，包括吸煙，都應遠離安裝、維修、拆卸和處置場所，在此期間，易燃製冷劑可能會釋放到周圍空間。在開始工作之前，應檢查設備周圍的區域，以確保沒有易燃危險或著火風險。應張貼禁止吸煙標誌。

**7) 通風區域**

在進入系統或進行任何高溫作業之前，確保該區域處於開放狀態或充分通風。在工作過程中應保持一定程度的通風。通風應安全地分散釋放的製冷劑，最好將其從外部排放到大氣中。

**8) 製冷設備檢查**

更換的電氣元件應適合用途並符合正確的規格。應始終遵守製造商的維護和服務指南。如有疑問，請諮詢製造商的技術部門尋求幫助。對使用可燃製冷劑的裝置應進行以下檢查：充注量與含製冷劑部件安裝房間的大小一致；

通風設備和出風口運行正常，沒有堵塞；

如果使用間接製冷回路，應檢查二次回路是否存在製冷劑；設備上的標記仍然清晰可見。難以辨認的標記和標誌應予以糾正；製冷管道或部件的安裝位置應避免暴露於任何可能腐蝕含製冷劑部件的物質，除非這些部件由具有固有抗腐蝕能力的材料製成，或者有適當的保護以防止腐蝕。

**9) 檢查電氣設備**

電氣元件的維修和維護應包括初始安全檢查和元件檢查程式。如果存在可能危及安全的故障，則在妥善處理之前，不得將電源連接到電路。如果故障不能立即糾正，但需要繼續運行，則應採用適當的臨時解決方案。應將情況報告給設備所有者，以便通知所有各方。初始安全檢查應包括：



電容器放電：應以安全的方式進行，以避免產生火花的可能性；  
充注、回收或清洗系統時，沒有帶電的電氣元件和線路暴露在外；  
接地連接具有連續性。

## 7. 密封元件的修理

- 1) 在修理密封元件過程中，在拆除密封蓋等之前，應將所有電源與正在工作的設備斷開。如果在維修過程中必須為設備供電，則最關鍵的點應有永久運行的洩漏檢測形式，以警告潛在的危險情況。
- 2) 應特別注意以下事項，以確保在對電氣元件進行操作時，不會改變外殼從而影響防護等級，包括電纜損壞、連接數量過多、端子不符合原始規格、密封件損壞、壓蓋安裝不正確等。

確保設備安裝牢固。

確保密封件或密封材料沒有退化，以確保其能夠起到防止可燃氣體進入的作用。更換零件應符合製造商的規格。

注意：使用矽密封膠可能會抑制某些類型的洩漏檢測設備的有效性。本安組件在處理之前不必隔離。

## 8. 本安組件維修

請勿在電路上施加任何永久性電感或電容負載，除非確保不會超過所用設備的允許電壓和電流。本安元件是唯一可以在有易燃氣體的情況下工作的類型。測試設備應處於正確的額定值。只能使用製造商指定的部件更換元件。其他部件可能會因洩漏而導致大氣中的製冷劑著火。

## 9. 佈線

檢查佈線是否會受到磨損、腐蝕、過度壓力、振動、銳邊或任何其他不利環境影響。檢查還應考慮壓縮機或風扇等造成的老化或持續振動的影響。

## 10. 可燃製冷劑檢測

在任何情況下都不得使用潛在的點火源尋找或檢測製冷劑洩漏。

不得使用鹵素燈（或任何其他使用明火的探測器）。

## 11. 洩漏檢測方法

以下洩漏檢測方法適用於含易燃製冷劑的系統。應使用電子檢漏儀檢測易燃製冷劑，但靈敏度可能不夠，或者可能需要重新校準。（檢測設備應在無製冷劑的區域進行校準。）確保檢測器不是潛在的點火源並且適合所使用的製冷劑。洩漏檢測設備應設置為製冷劑LFL的百分比，並應根據所使用的製冷劑進行校準，並確認適當的氣體百分比（最大25%）。檢漏液適用於大多數製冷劑，但應避免使用含氯的清潔劑，因為氯可能與製冷劑發生反應並腐蝕銅管。如果懷疑有洩漏，應移走/熄滅所有明火。如果發現需要鈎焊的製冷劑洩漏，則應從系統中回收所有製冷劑，或將系統中遠離洩漏的部分隔離（通過截止閥）。然後，在鈎焊過程之前和過程中，應通過系統吹掃無氧氮氣（OFN）。

## 12. 清除和排空

當進入製冷劑回路進行維修或出於任何其他目的時，應使用常規程式。然而，重要的是遵循最佳做法，因為需要考慮易燃性。不得通過鈎焊打開製冷系統。應遵循以下程式：

清除製冷劑；

用惰性氣體吹掃電路；

排空；

再次用惰性氣體吹掃；

通過切割或鈎焊打開電路。

應將充注的製冷劑回收到適當的回收鋼瓶中。系統應使用OFN進行沖洗以確保設備安全。這一過程可能需要重複幾次。此任務不得使用壓縮空氣或氧氣。

沖洗時用OFN打破系統中的真空並繼續填充直到達到工作壓力，然後排放到大氣中，最後抽真空來實現。應重複此過程，直到系統內沒有製冷劑為止。

當使用最終OFN充注時，系統應排放至大氣壓力以進行工作。如果要在管道上進行鈎焊操作，此操作至關重要。

確保真空泵的出口不靠近任何點火源，並且有通風。

## 13. 充注程式

除常規充注程式外，還應遵循以下要求。確保在使用充注設備時不會發生不同製冷劑的污染。軟管或管線應盡可能短，以儘量減少其中的製冷劑含量。

鋼瓶應保持直立。

在向系統充注製冷劑之前，確保製冷系統已接地。

充注完成時給系統貼上標籤（如果還未貼）。

應特別注意不要將製冷系統裝得過滿。

在給系統充注之前，應使用OFN對其進行壓力測試。系統應在充注完成後試運轉之前進行洩漏測試。離開現場前應進行後續洩漏測試。

#### 14. 停止運行

在執行此程式之前，技術人員必須完全熟悉設備及其所有細節。建議的良好做法是安全回收所有製冷劑。

在執行任務之前，應採集油和製冷劑樣本，以防在重新使用回收的製冷劑之前需要進行分析。在任務開始之前，必須連接電源。

- a) 熟悉設備及其操作。
- b) 電氣隔離系統。
- c) 在嘗試該程式之前，請確保：  
必要時可使用機械搬運設備來搬運製冷劑鋼瓶；  
所有個人防護設備都可用並正確使用；  
回收過程始終由合格人員監督；  
回收設備和鋼瓶符合相應的標準。
- d) 如果可能，抽空製冷系統。
- e) 如果無法實現真空，則製作一個歧管，以便可以從系統的各個部分排出製冷劑。
- f) 在回收之前確保鋼瓶位於秤上。
- g) 啟動回收機並按照製造商的說明進行操作。
- h) 請勿過度充注鋼瓶（液體充注體積不超過80%）。
- i) 不得超過鋼瓶的最大工作壓力，即使是暫時的。
- j) 當鋼瓶正確加注並完成該過程後，確保立即將鋼瓶和設備移出現場，並關閉設備上的所有隔離閥。
- k) 回收的製冷劑除非經過清潔和檢查，否則不得充注到另一個製冷系統中。

#### 15. 標籤

設備應貼上標籤，說明其已停用並排空製冷劑。標籤應注明日期並簽名。確保設備上有標籤，說明設備含有易燃製冷劑。

#### 16. 回收

從系統中移除製冷劑時，無論是為了維修還是停用，建議的良好做法安全是移除所有製冷劑。將製冷劑轉移到鋼瓶中時，確保僅使用合適的製冷劑回收鋼瓶。確保可以使用正確數量的鋼瓶來容納系統總充氣量。使用的所有鋼瓶都指定用於回收的製冷劑並有相應標記（即用於回收製冷劑的特殊鋼瓶）。鋼瓶應配有狀態良好的壓力釋放閥和相關截止閥。空的回收鋼瓶應排空，如果可能，回收之前應冷卻。回收設備應處於良好的工作狀態，並附有一套關於適用於可燃製冷劑回收的設備的說明。此外，應備有一套校準過並處於良好工作狀態的秤。軟管應配備無洩漏斷開接頭且狀況良好。在使用回收機之前，檢查是否處於良好的工作狀態，是否得到了適當的維護，並且所有相關的電氣元件都已密封，以防止在製冷劑洩漏時著火。如有疑問，請諮詢製造商。

回收的製冷劑應使用適當的回收鋼瓶退回給製冷劑供應商，並安排相關的廢物轉移單。請勿在回收裝置中混合製冷劑，尤其是在鋼瓶中。如果要清除壓縮機或壓縮機油，請確保將排空到可接受的水準，以確保潤滑劑中不會殘留易燃製冷劑。排空過程應在將壓縮機返還給供應商之前進行。只能對壓縮機本體採用電加熱來加速這一過程。從系統中排油時，應安全進行。

當使用易燃製冷劑時，電器應存放在通風良好的地方。

## 工作溫度

當空調在以下溫度範圍之外使用時，某些安全保護功能可能會啟動並導致設備無法使用。

製冷運行	室外溫度	18°C-43°C (64°F-109°F)
	室內溫度	18°C ~ 52°C (64°F ~ 126°F) (適用於特殊熱帶型號)
加熱運行	室外溫度	-5°C-24°C (23°F-76°F)
	室內溫度	0°C-27°C (32°F-80°F)

要進一步優化設備的性能，請執行以下操作：

- 保持門窗關閉。
- 房間空調的容量必須適合房間大小，以便高效地運行。
- 請勿堵塞空氣入口或出口。
- 定期檢查和清潔過濾網。
- 如果設備電源不是指定額定值±10%，則設備可能無法運行且保險絲可能熔斷。
- 夜間空調發出的噪音會比白天大。這是因為夜間環境噪音相對較低。如果您覺得噪音太大，請將恆溫器切換到較低的數字。

## 裝置部件識別

注意：不同型號有不同的前面板和機櫃。本手冊中的插圖僅用於說明。室內機的實際外形可能略有不同，請以實際外形為準。參考下圖：

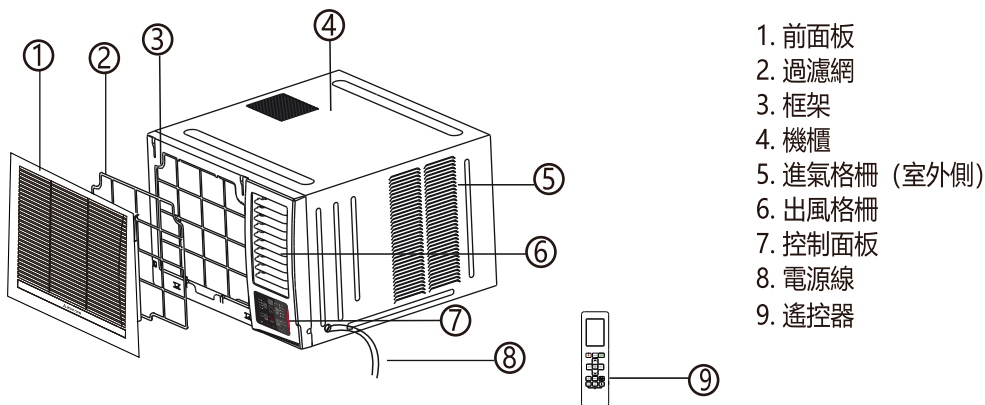

### 配件

密封件 (※)  
(用於排水  
接頭)



1個

排水接頭 (※)



1個

排水盤 (※)



1個

橡膠塞



1 - 2個 (取決  
於型號)

螺釘



2個 (對於某些裝  
置，用於固定前面  
板) 2個或4個 (用  
於安裝排水盤)

木螺釘 (可  
選) (※)



8個 (取決於購買的  
型號)

PVC護套和  
紮帶 (※)



1個

4個

【※】型號相關

## 通風口控制

通風口控制位於控制旋鈕上方。不同型號的操作方法和外形可能有所不同（見下圖）。為獲得最大製冷效率，請關閉通風口，從而使內部空氣迴圈。打开通風口排出不新鮮的空氣。

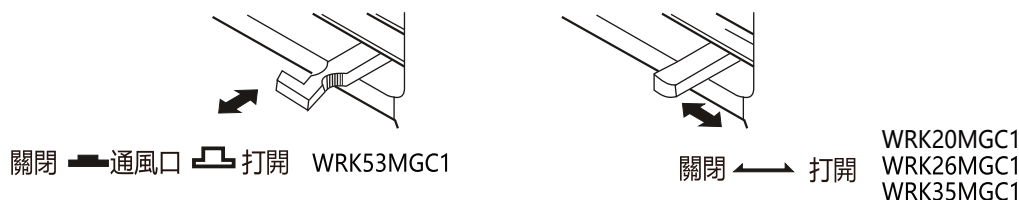

## 操作說明

**注意：**不同型號有不同的操作面板。您購買的空調可能並不具備以下描述的所有功能。請檢查購買設備的操作面板。以下圖形用於說明，請以實際外形為準。

**注意：**某些型號沒有中速功能和（或）自動模式功能和（或）擺動功能。

### 電源：

按電源鍵打開/關閉設備。

### 模式：

按“模式”鍵選擇合適的操作模式。模式選擇將在自動、製冷、風扇和除濕之間交替。“模式”選項旁的指示燈將亮起，標識所選模式。



WRK20MGC1  
WRK26MGC1  
WRK35MGC1

### 除濕：

此模式用於降低房間內的濕度。在此模式下，無法選擇風扇速度。風扇電機以低速運行。保持門窗關閉可以獲得最佳除濕效果。  
注意：在抽濕模式下，您無法在某些型號上調節溫度。

### 製冷：

溫度設置可在17°C至30°C之間調節。可以選擇所需的風扇速度。

### 自動：

風扇電機在自動模式下保持中速。設備將根據實際溫度與所需室溫之間的溫差從風扇、製冷中選擇適當的操作模式。某些沒有中速的型號，風扇電機在自動模式下以高速運行。

注意：在自動模式下，您不能同時調整某些型號的溫度和風扇速度。  
在自動模式下，您只是無法調整某些型號的風扇速度。

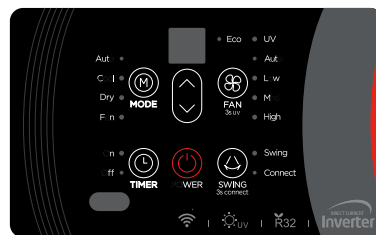

WRK53MGC1

### 風扇模式：

按“模式”鍵選擇風扇模式，您可以按“風扇”鍵選擇所需的風扇速度但不能調節溫度。

#### ▲溫度增加設置：

按▲鍵增加設備的設定（運行）溫度。每次按下此鍵時，溫度會升高1°C。最高設置30°C。

#### ▼溫度降低設置：

按▼鍵降低設備的設定（運行）溫度。每次按下此鍵時，溫度會降低1°C。最低設置17°C。

### 風扇：

按此鍵可啟動適當的風扇速度設置。每次按下此鍵都會在自動、低、中、高風扇速度選項之間交替。風扇速度選項旁的指示燈將亮起，標識所選的風扇速度。

### 注意：

對於某些型號，按住風扇按鈕3秒鐘以啟動UV功能，LED顯示屏顯示“On”3秒鐘。UV(UltraViolet)功能將有助於淨化內部空氣。再次按住FAN按鈕3秒可停止UV功能，LED顯示屏顯示“OFF”3秒。

### 擺動：

按“擺動”鍵啟動自動擺動功能。“擺動”鍵旁的指示燈將亮起，表明所選模式正在運行。垂直百葉將前後（左右）擺動自動交替吹掃空氣，以實現舒適的製冷。要停止擺動功能，請再次按下“擺動”鍵，鍵旁的指示燈將熄滅。

### 無線操作：

首次使用無線網絡功能，長按擺動鍵3秒啟動無線網絡連接模式。LED DISPLAY顯示“AP”表示您可以設置無線網絡連接。如果在8分鐘內連接（路由器）成功，本機將自動退出無線網絡連接模式，無線指示燈亮起。如果在8分鐘內連接失敗，設備將自動退出無線網絡連接模式。注意：空調在進入配置模式(AP)後，用戶屆時將無法操控空調直至配置結束或8分鐘過後。如需即時取消配置模式(AP)，用戶可通過斷開電源或拔下電插，重啟空調。

### 計時器：

- 當設備開啟時，按下計時器按鈕將啟動自動停止程式，計時器關閉指示燈亮起。按向上或向下按鈕選擇所需時間。在10秒內再次按下計時器按鈕，自動啟動程式啟動，計時器開啟指示燈亮起。按向上或向下按鈕選擇所需的自動啟動時間。
- 當設備關閉時，按下計時器按鈕啟動自動啟動程式，在10秒內再次按下將啟動自動停止程式。
- 按住向上或向下按鈕以0.5小時的增量更改自動時間，最多到10小時，然後以1小時的增量更改到24小時。控制器將倒計時剩餘時間，直到啟動。
- 如果在10秒內沒有操作，系統將自動恢復顯示之前的溫度設置。
- 任何時候打開或關閉設備或將計時器設置調整為0.0將取消自動啟動/停止計時器程式。

### 計時器：

按“計時器”鍵啟動“自動啟動/自動停止”計時器功能。

自動啟動/停止程式可設置為0 ~ 12小時。每次按下“計時器”鍵都會以1小時的增量增加所選時間。

### 睡眠：

按住“擺動”鍵2秒鐘或使用遙控器啟動“睡眠”功能。按住“擺動”鍵2秒鐘或再次使用遙控器禁用“睡眠”功能。在製冷模式下，選擇“睡眠”模式後，製冷溫度設定點每小時會增加1°C。兩小時後，設定點將繼續保持該溫度，風扇電機將保持低速。在加熱模式下，選擇“睡眠”模式後，加熱溫度設定點將每小時降低1°C。兩小時後，設定點將繼續保持此溫度，風扇電機將保持低速。對於變頻式機型，新溫度將保持7小時，然後設備退出睡眠模式並關閉。使用“睡眠”模式將減少噪音，營造舒適的睡眠環境。

**注意：**此功能在除濕和僅風扇運行時不可用。

### 增強功能（僅限部分型號）

在製冷模式下，按遙控器上的增強按鈕，空調進入強力製冷運行。再按一次取消增強功能。

### 節能功能（僅限部分型號）

在製冷模式下按遙控器的 節能 鍵進入節能模式。

### LED顯示屏：

- 在僅風扇模式下顯示室溫，在其他模式下顯示設定溫度。
- 在計時器設置過程中顯示時間，10秒後系統將恢復顯示設定溫度。

### 顯示錯誤代碼：（變頻式）

- |                |                              |
|----------------|------------------------------|
| E0：室內EEPROM錯誤； | F3：排氣溫度感測器錯誤；                |
| E1：室內外通訊錯誤；    | F4：室外電動EE錯誤；                 |
| E3：室內風扇電機轉速失控； | P0：IPM模組錯誤；                  |
| E4：室溫感測器錯誤；    | P1：電壓過高/過低保護；                |
| E5：蒸發器溫度感測器錯誤； | P2：IPM高溫保護；                  |
| EC：製冷劑洩漏檢測；    | P3：室外溫度過低保護<br>（適用於製冷和加熱機型）； |
| F0：電流超載保護；     | P4：壓縮機位置保護；                  |
| F1：室外溫度感測器錯誤；  | P7：室外IGBT感測器錯誤。              |
| F2：冷凝器溫度感測器錯誤； |                              |

### 顯示錯誤代碼：（僅限部分型號）

錯誤代碼出現在室內機窗口顯示中，並以以下字母開頭：EH(xx)、EL(xx)、EC(xx)、PH(xx)、PL(xx)、PC(xx)。

**注意：**由於本機發生故障，本機可能會停止運行。如果發生這種情況，顯示屏上可能會出現如下所示的錯誤代碼。請等待 10 分鐘，因為問題可能會自行解決。如果沒有，請斷開電源，然後重新連接。打開設備。如果問題仍然存在，請斷開電源並聯繫客戶服務。

## 風向控制

### 氣流方向調節

#### 對於帶手動控制杆的機型（手動）

要調整氣流方向，用手輕輕向左或向右移動控制杆，直到獲得所需的氣流方向（見圖C）。

### 垂直氣流調節（手動）

裝置運行時，用手調節百葉，改變垂直氣流方向。可以握住百葉並移動到所需位置，從而設置氣流的垂直角度（見圖D）。有些機組的百葉連杆上裝有凸塊，可在機架左側的三個凹槽之間以0-15度的角度移動（見圖E）。

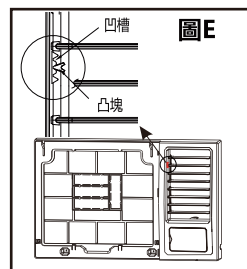
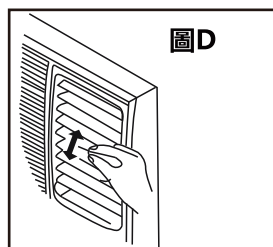
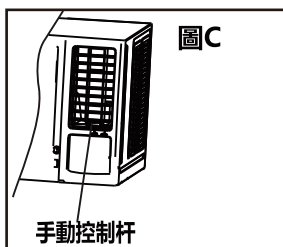

# 保養和維護

## ⚠️ 清潔或維護之前

在清潔或維護之前，請務必關閉空調系統並斷開其電源。

## 清潔設備

### ⚠️ 重要

機櫃和前面板可用無油布擦拭或用布蘸溫水與溫和洗碗液溶液清洗。徹底沖洗並擦乾。

- 請勿在空調附近使用油漆或髮膠等易燃噴霧劑。
- 請勿使用苯、酒精、汽油、酸、油漆稀釋劑、拋光粉或其他溶劑清潔本機，否則可能會損壞設備。
- 請勿使用超過50 °C (122 °F) 的水清潔前面板，否則會導致面板變形或變色。
- 控制器內部或周圍過多的水可能會損壞空調。在擦拭乾淨之前，一定要擰乾布上多餘的水。

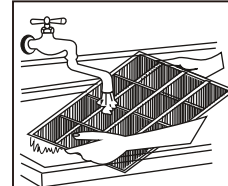
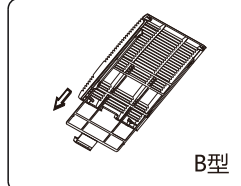
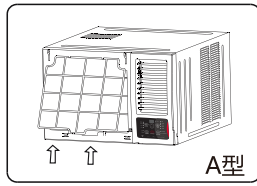
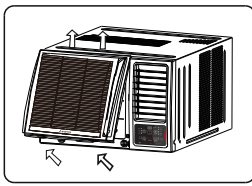

## 清潔過濾網

過濾網堵塞會降低設備的製冷效率並增加運行噪音。確保在頻繁操作期間每兩周（或根據需要）清潔一次過濾網。

1. 握住前面板下方的插槽，向外提起，取下前面板。
2. 捏住過濾網下方的把手，使過濾網呈拱形，從卡槽中從下往上取出（A型）。抓住過濾網的把手，然後將其向下滑動以取下過濾網（B型）。
3. 用溫肥皂水清潔過濾網。水溫應低於40 °C (104 °F) 以防止過濾網變形。
4. 如果過濾網帶有小型過濾網，請使用手持真空吸塵器清潔此過濾網。
5. 用清水沖洗過濾網，然後甩掉多餘的水。
6. 在陰涼乾燥處晾乾，避免陽光直射。

如果過濾網有一個小的過濾網（可選）可安裝在四個位置中的任何一個。用手持真空吸塵器清潔過濾網。

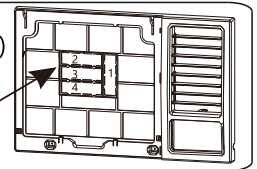

### ⚠️ 小心

切勿在沒有過濾網的情況下運行空調，因為灰塵/污垢顆粒會導致設備故障。

### 冬季儲存

如果要在冬季存放空調，請按照安裝說明小心地將其從窗戶上取下。用塑膠蓋住或將其放回原包裝箱中。

# 排水

冷凝水的處理方法如下：

**底部排水**（僅適用於設計有底部排水孔的裝置。）

- 取下機櫃底部的橡膠塞（如果有）
- 從附件中取出排水盤和螺釘。
- 用螺釘將排水盤固定在機櫃底部。
- 將延長排水軟管（當地購買）連接到排水盤的出口。

**注意：**底部排水會輕微影響製冷性能，但可以減少因噴灑冷凝水而產生的噪音。對於泵加熱，必須選擇底部排水。

**後排水**

- 將密封件安裝到排水接頭上（附件提供）。
- 將排水接頭插入後排水孔，將其旋轉90°以貼合。
- 將延長排水軟管（根據安裝長度要求在當地購買）連接到排水接頭。
- 確保用橡膠塞堵住底部排水孔。

**注意：**後排水會輕微影響製冷性能，但可以減少因噴灑冷凝水而產生的噪音。

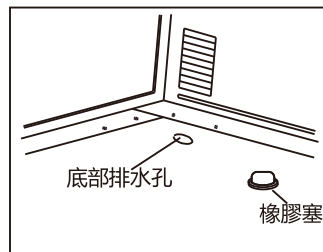

底部排水

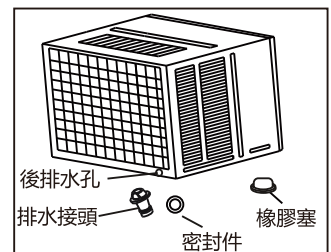

後排水

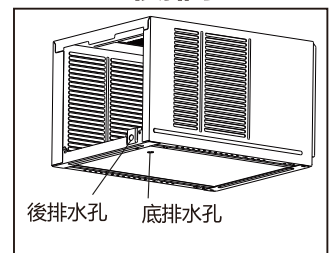
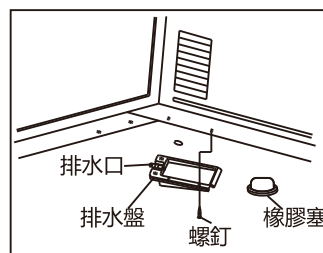

不排水

## 不排水

如果選擇製冷時不排水，則應用橡膠塞堵住機組底部和後排水孔。冷凝水噴到冷凝器，提高製冷性能。

**注意：**選擇不排水時，空調將具有完美的製冷效率，但可能會因噴出冷凝水而產生較大的噪音。或當有過多冷凝水時，會造成溢水的現象，如果您對噪音敏感或擔心有溢水的風險，請不要選擇該選項。

## 產品注意事項

- 額定製冷性能是在不排水狀態下測試的。
- 確保在使用橡膠塞和接頭時周圍不會漏水。如果發現洩漏，請密封。

## 安裝說明

### 安裝前

**小心：**安裝前，請從紙箱內取出所有包裝以及放入側百葉的所有外掛程式。

#### 第1步：選擇最佳位置

1. 為避免振動和噪音，請確保設備安裝牢固。
2. 將設備安裝在陽光不會直接照射到的地方。如果設備受到陽光直射，請搭建遮陽篷為機櫃遮陰。
3. 櫃體背面50釐米內不得有柵欄、牆壁等障礙物，以免冷凝器散熱。外界空氣限制會大大降低空調的製冷和製熱效率。
4. 將設備向外稍微傾斜向下安裝，以免冷凝水洩漏到室內（約3~4°）。
5. 將設備底部安裝在高於地面75~150釐米的位置。
6. 電源線必須連接到獨立的電路上。黃/綠線必須接地。

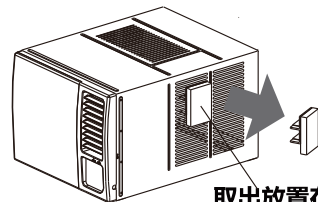

取出放置在側百葉中的外掛程式

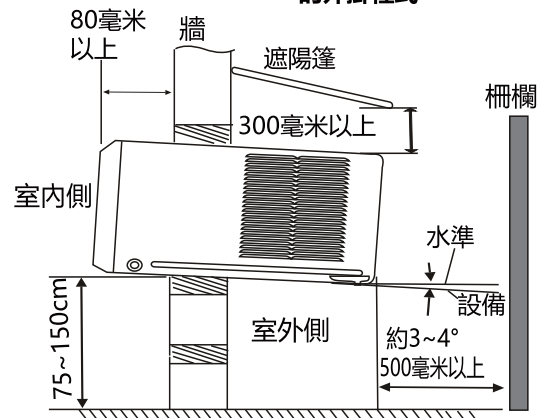

**小心**

機櫃的所有側百葉都必須暴露在結構的外部。

選項A

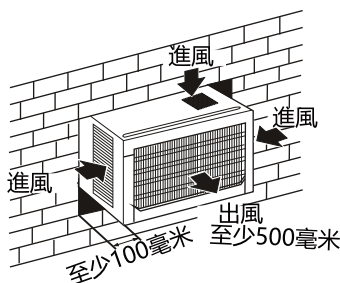

選項B

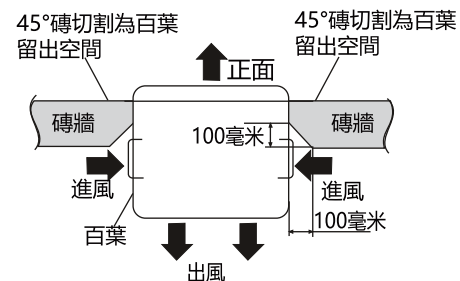

#### 第2步：取下前面板和過濾網

1. 從包裝中取出空調。
2. 握住前面板下方的插槽，向外提起，取下前面板（見圖1）。
3. 抓住過濾網末端的拉環，將其向上提起，然後朝向自己拉，將過濾網拉出（見圖2）。

#### 第3步：取下機架

1. 拆下機架底部的兩顆螺釘（見圖3）。
  2. 斷開耦合器插頭並確保不會干擾溫度感測器電纜。握住機架的左下側，將其向上提起以解鎖下側，然後朝向自己將其取下（見圖4）。
- 注意：對於某些設備，前面板和機架不安裝在設備背面，不需要第2步和第3步。

#### 第4步：取下機櫃

注意：根據機型不同，機櫃拆卸略有差異。

##### A型：

1. 取下固定主機殼固定支架的一顆螺釘，然後取下主機殼固定支架，如圖5A所示。
2. 抓住主機殼上的把手，小心地將空調滑出機櫃。（見圖6）



圖1



圖2

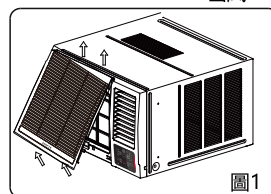

圖3

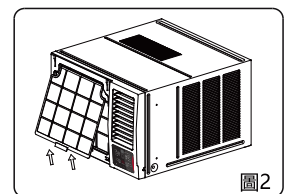

圖4

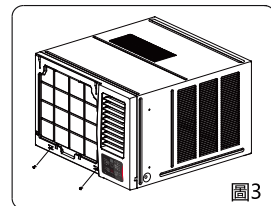

圖5A - A型

### B型：

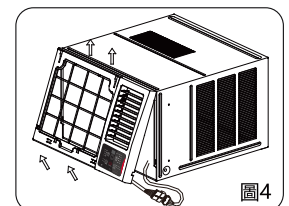
1. 取下固定主機殼固定支架的一顆螺釘，然後取下主機殼固定支架。取下機櫃背面的兩顆螺釘，如圖5B所示。
2. 抓住主機殼上的把手，小心地將空調滑出機櫃。（見圖6）

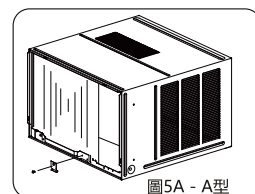

圖5B - B型

### C型：

1. 如圖5C所示，取下位於機櫃兩側和背面的四顆螺釘。
2. 抓住主機殼上的把手，小心地將空調滑出機櫃。（見圖6）

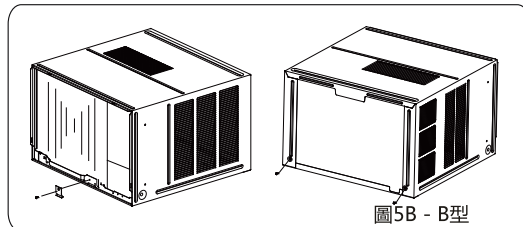

圖5C - C型

### D型：

1. 取下固定主機殼固定支架的一顆螺釘，然後取下主機殼固定支架。（見圖5D）
2. 如圖5D所示，取下機櫃兩側和背面的四顆螺釘。
3. 抓住主機殼上的把手，小心地將空調滑出機櫃。（見圖6）

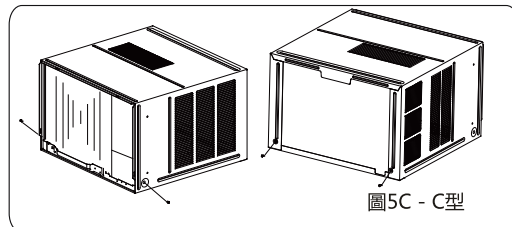

圖5D - D型

## 第5步：安裝機櫃

**注意：**裝置可由下方的實心機架支撐，或由實心頭頂支架上的吊架支撐（需單獨購買，請聯繫經銷商）。

1. 需要排水時，將放水塞安裝在底盤上。
2. 準備牆上的孔，使機櫃底部得到很好的支撐，頂部間隙最小，進風百葉的間隙如上一頁所示（圖選項A和B）。應密封從外部到腔體的孔。機櫃應向後傾斜約5~7毫米，以便將操作過程中形成的水排出。
3. 將機櫃安裝到牆上並固定。確保泡沫密封沒有損壞。對內部和外部周圍的縫隙加薄片、密封或填充，以提供良好的外觀和抵禦天氣、昆蟲和齧齒動物的保護。（見圖7）

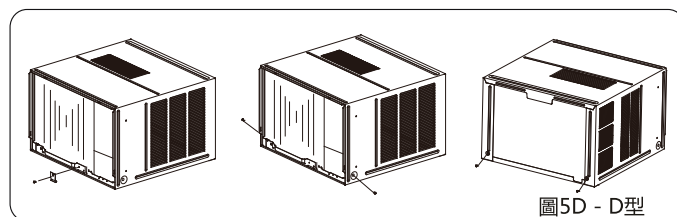

圖6



圖7

## 第6步：將設備安裝到機櫃中

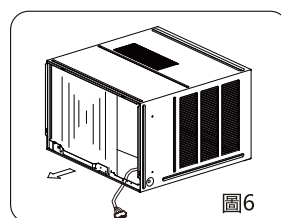
1. 將設備滑入機櫃，直到牢牢靠在機櫃後部。需要注意確保機櫃上的泡沫密封條保持原位（見圖8）。
2. 將空調連接到電源並將多餘的電線放置在空調底座下方。
3. 將主機殼固定支架卡入機櫃底部導軌，並用提供的螺釘固定在底座上。

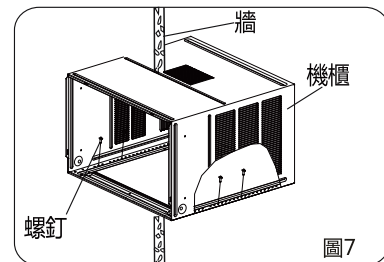
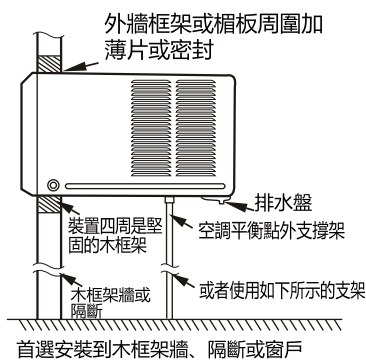

首選安裝到木框架牆、隔斷或窗戶

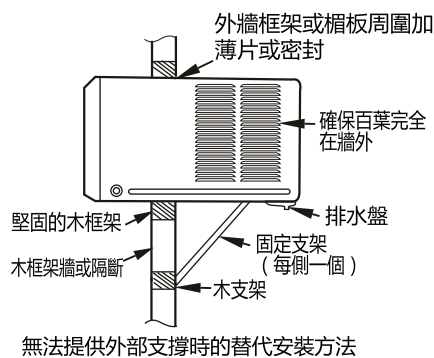

無法提供外部支撐時的替代安裝方法



圖8



圖9

## 第7步：安裝框架

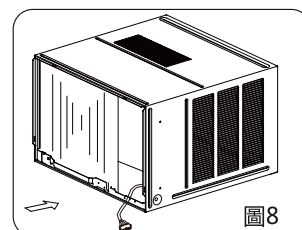
1. 鉤住機架的上邊緣，然後連接耦合器插頭並確保不會干擾溫度感測器電纜（見圖9）。
2. 按壓機架的兩側和下邊緣，用兩顆螺釘固定在機架底部。（見圖10）

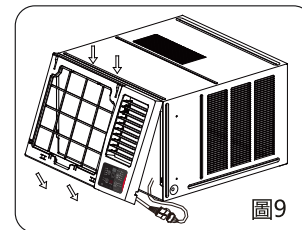

圖10



圖11

## 第8步：安裝空氣過濾網和前面板

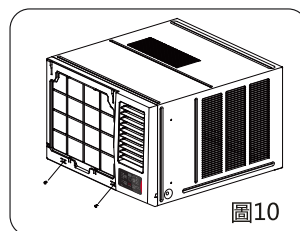
1. 將空氣過濾網從上向下插入機架的插槽中。（見圖2）
2. 將前面板掛在機架的搭扣上，然後將前面板按入機架的插槽，直到聽到啞嗒聲（見圖11）。
3. 開啟設備。檢查裝置運行情況，並在安裝後檢查振動。
4. 將排水盤安裝到機櫃上，並在需要時將排水軟管連接到合適的位置。

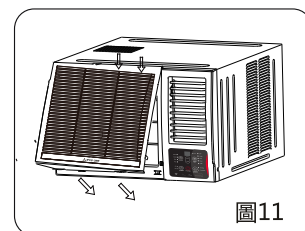

注意：對於電源線在左側的裝置，請執行以下步驟：

1. 將電源線向左側拉直（見圖a和b）。
2. 用紮線帶將電源線上的PVC保護套纏繞在孔位（見圖c）。
3. 將電源線綁在機架上（見圖d和e）（僅適用於機身尺寸為600 \* 380 \* 560毫米的裝置）。
4. 按照上述第6步和第7步安裝機架和前面板。

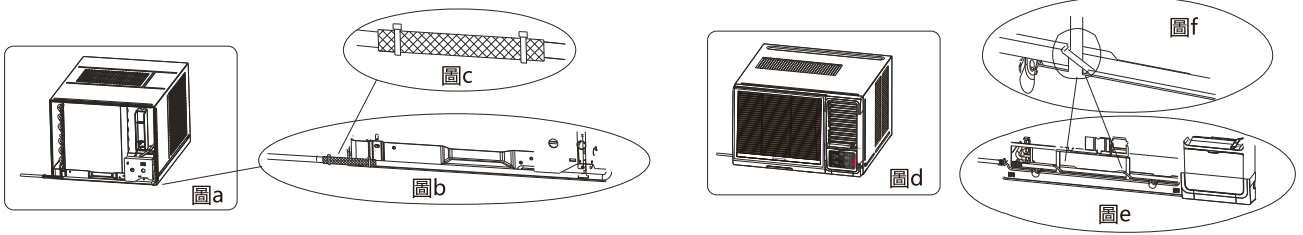

## 故障排除

### ⚠ 安全須知

如果出現以下任何一種情況，請立即關閉設備！

- 電源線損壞或異常發熱
- 有燒焦的氣味
- 設備發出響亮或異常的聲音
- 電源保險絲熔斷或斷路器頻繁跳閘
- 水或其他物體落入或落出本機

**請勿試圖自己解決這些問題！立即聯繫授權服務提供者！**

### 常見問題

問題	可能原因	該怎麼辦
空調不啟動	空調插頭沒有插好。	- 確保空調插頭完全插入插座並打開。
	保險絲熔斷/斷路器跳閘。	- 檢查房屋保險絲/斷路器盒並更換保險絲或重置斷路器。
	電源故障。	- 如果發生電源故障，請關閉電源並斷開/拔下電源線。恢復供電後，重新連接（插上）電源線，接通電源，等待3分鐘重新啟動空調，防止壓縮機過載跳閘。
空調沒有像應有的那樣冷卻	氣流受到限制。	- 確保沒有窗簾、百葉窗或家具擋住了空調的前部。
	過濾網骯髒。	- 至少每 2 周清潔一次過濾網。 - 請參閱操作說明部分。
	房間可能很熱。	- 當你第一次打開空調時需要留出時間讓房間冷卻下來
	冷空氣外漏。	- 檢查房間是否漏風，盡可能讓空調在密閉的空間內運行。 - 將空調出風口設置為關閉位置
	冷卻盤管結冰了。	- 請參閱下面的空調凍結。
空調結冰	冰會阻擋氣流並阻止空調冷卻房間。	- 將風扇設置為 MED 或 HIGH，直到冰融化。

# 規格

## 設備尺寸：

型號 ( Btu/h )	機身尺寸 ( 高×闊×深 ) ( 毫米 )
5000~6000	320x415x445
	346x535x450
7000~9000	346x535x450
	350x450.6x675
9000~12000	350x450.6x675
	400x640x560
	380x560x600
15000~24000	428x660x780
	428x660x780

**注意：**針對不同的定制需求，面板深度可能略有不同，因此“深”僅供參考。

## 選擇正確的電纜尺寸

所需的電源線、信號線、保險絲和開關的尺寸由設備的最大電流決定。最大電流顯示在設備側面板的銘牌上。請參閱此銘牌以選擇正確的電纜、保險絲或開關。

使用的電源線體最小線徑要求：

電器額定電流 ( A )	最小線徑 ( 平方毫米 )
$> 3 \leq 6$	0.75
$> 6 \leq 10$	1
$> 10 \leq 16$	1.5
$> 16 \leq 25$	2.5
$> 25 \leq 32$	4
$> 32 \leq 40$	6

設計和規格如有更改，恕不另行通知。詳情請諮詢銷售機構或製造商。手冊的任何更新都會上傳到服務網站，請檢查最新版本。

## 產品中有害物質的名稱及含量

部件名稱	有害物質					
	鉛 (Pb)	汞 (Hg)	鎘 (Cd)	六價鉻 (Cr (VI))	多溴聯苯 (PBB)	多溴二苯醚 (PBDE)
壓縮機及其配件	○	○	×	○	○	○
壓縮機包套	○	○	○	○	○	○
製冷劑	○	○	○	○	○	○
換熱器	○	○	○	○	○	○
閥類、管路件	×	○	○	○	○	○
螺釘、螺栓等緊固件	○	○	○	○	○	○
其他金屬件	○	○	○	○	○	○
電機	×	○	○	○	○	○
遙控器及電池	×	○	○	○	○	○
電控板及電器元器件	×	○	×	○	○	○
電源線及連接線	×	○	○	○	○	○
發泡件	○	○	○	○	○	○
塑膠件	○	○	○	○	○	○
橡膠件	○	○	○	○	○	○
印刷類	○	○	○	○	○	○

○:表示該有毒有害物質在該部件所有均質材料中的含量在GB/T26572規定的限量要求以下。

×:表示該有毒有害物質至少在該部件的某一均質材料中的含量超出GB/T26572規定的限量要求，但符合《達標管理目錄限用物質應用例外清單》中的可豁免要求，後續隨著技術上的進度將被逐漸改進。

廢棄時請注意：

1. 本產品安裝後的包裝材料等廢棄物，請勿亂丟，須進行分類處理並放置於對應的垃圾分類收集箱。
2. 產品廢棄時請送至有資質的回收點進行妥善處理。

# Warning

## Read Warning Before Operation and Installation

Incorrect installation due to ignore of instructions can cause serious damage or injury.



## WARNING

### 1. Installation (Space)

- Where refrigerant pipes shall be compliance with national gas regulations.
- That mechanical connections shall be accessible for maintenance purposes.
- In cases that require mechanical ventilation, ventilation openings shall be kept clear of obstruction.
- When disposing of the product is used, be based on national regulations, properly processed.

### 2. Servicing

- Any person who is involved with working on or breaking into a refrigerant circuit should hold a current valid certificate from an industry-accredited assessment authority, which authorises their competence to handle refrigerants safely in accordance with an industry recognised assessment specification.

3. Maintenance and repair requires the assistance of other skilled personnel shall be carried out under the supervision of the person competent in the use of flammable refrigerants.

4. Do not use means to accelerate the defrosting process or to clean, other than those recommended by the manufacturer.

5. The appliance shall be stored in a room without continuously operating ignition sources (for example: open flames, an operating gas appliance or an operating electric heater)

6. Be more careful that foreign matter (oil, water, etc) does not enter the piping. Also, when storing the piping, securely seal the opening by pinching, taping, etc.

7. Do not pierce or burn.

8. Be aware that refrigerants may not contain an odour.

9. All working procedure that affects safety means shall only be carried by competent persons.

10. Appliance shall be stored in a well-ventilated area where the room size corresponds to the room area as specific for operation.

11. The appliance shall be stored so as to prevent mechanical damage from occurring.





12. The appliance is using mildly flammable refrigerant R32 and tested to comply with IEC 60335-2-40. There is no minimum room area requirement for the appliance.

13. The installation height shall not be lower than 0.75m.

## Transportation, marking and storage for units

1. Transport of equipment containing flammable refrigerants  
Compliance with the transport regulations
2. Marking of equipment using signs  
Compliance with local regulations
3. Disposal of equipment using flammable refrigerants  
Compliance with national regulations
4. Storage of equipment/appliances  
The storage of equipment should be in accordance with the manufacturer's instructions.
5. Storage of packed (unsold) equipment  
Storage package protection should be constructed such that mechanical damage to the equipment inside the package will not cause a leak of the refrigerant charge.  
The maximum number of pieces of equipment permitted to be stored together will be determined by local regulations.

## Explanation of symbols displayed on the unit

	WARNING	This symbol shows that this appliance used a mildly flammable refrigerant. If there frigerant is leaked and exposed to an external ignition source, there is a risk of fire.
	CAUTION	This symbol shows that the user's manual should be read carefully.
	CAUTION	This symbol shows that a service personnel should be handling this equipment with reference to the installation manual.
	CAUTION	This symbol shows that information is available such as the user's manual or installation manual.

# Table of Contents

<b>Safety Precautions</b> .....	<b>03</b>
<b>Unit Parts Identification</b> .....	<b>09</b>
<b>Operation Instructions</b> .....	<b>10</b>
<b>Care and Maintenance</b> .....	<b>13</b>
<b>Water Drainage</b> .....	<b>13</b>
<b>Installation Instructions</b> .....	<b>15</b>
<b>Troubleshooting</b> .....	<b>18</b>
<b>Specifications</b> .....	<b>19</b>

## Environment

Effective from 31 December 2018, the disposal licensing control, import and export permit control and landfill disposal ban in respect of abandoned regulated electrical equipment (REE) have commenced. Any person who is engaged in the storage, treatment, reprocessing or recycling of abandoned REE must obtain a waste disposal licence; a permit is required for the import and export of abandoned REE; and abandoned REE is no longer be accepted for disposal at the landfills and other designated waste disposal facilities (e.g. refuse transfer stations).

# Safety Precautions

## Read Safety Precautions Before Operation and Installation

**Incorrect installation due to ignoring instructions can cause serious damage or injury.**

The seriousness of potential damage or injuries is classified as either a **WARNING** or **CAUTION**.



### WARNING

This symbol indicates the possibility of personnel injury or loss of life.



### CAUTION

This symbol indicates the possibility of property damage or serious consequences.



### WARNING

This appliance is not intended for use by persons (including children) with reduced physical, sensory or mental capabilities, or lack of experience and knowledge, unless they have been given supervision or instruction concerning use of the appliance by a person responsible for their safety. Children should be supervised to ensure that they do not play with the appliance.



### WARNINGS FOR PRODUCT USE

- This appliance is using R32 mildly flammable refrigerant.
- If an abnormal situation arises (like a burning smell), immediately turn off the unit and disconnect the power. Call your dealer for instructions to avoid electric shock, fire or injury.
- **Do not** insert fingers, rods or other objects into the air inlet or outlet. This may cause injury, since the fan may be rotating at high speeds.
- **Do not** use flammable sprays such as hair spray, lacquer or paint near the unit. This may cause fire or combustion.
- **Do not** operate the air conditioner in places near or around combustible gases. Emitted gas may collect around the unit and cause explosion.
- **Do not** operate your air conditioner in a wet room such as a bathroom or laundry room. Too much exposure to water can cause electrical components to short circuit.
- **Do not** expose your body directly to cool air for a prolonged period of time.
- **Do not** allow children to play with the air conditioner. Children must be supervised around the unit at all times.
- If the air conditioner is used together with burners or other heating devices, thoroughly ventilate the room to avoid oxygen deficiency.
- In certain functional environments, such as kitchens, server rooms, etc., the use of specially designed air-conditioning units is highly recommended.
- Unplug the unit or disconnect the power supply to the unit if strange sounds, smell, or smoke comes from it.
- To further optimize the performance of your unit, keep doors and windows closed during operation.
- Pay attention when unpacking and installing. Sharp edges could cause injury.

### CLEANING AND MAINTENANCE WARNINGS

- Turn off the device and disconnect the power before cleaning. Failure to do so can cause electrical shock.
- **Do not** clean the air conditioner with excessive amounts of water.
- **Do not** clean the air conditioner with combustible cleaning agents. Combustible cleaning agents can cause fire or deformation.



### CAUTION

- Turn off the air conditioner and disconnect the power if you are not going to use it for a long time.
- Turn off and unplug the unit during storms.
- Make sure that water condensation can drain unhindered from the unit.
- **Do not** operate the air conditioner with wet hands. This may cause electric shock.
- **Do not** use device for any other purpose than its intended use.
- **Do not** climb onto or place objects on top of the outdoor unit.
- **Do not** allow the air conditioner to operate for long periods of time with doors or windows open, or if the humidity is very high.



## ELECTRICAL WARNINGS

- Only use the specified power cord. If the power cord is damaged, it must be replaced by the manufacturer, its service agent or similarly qualified persons in order to avoid a hazard.
- Keep power plug clean. Remove any dust or grime that accumulates on or around the plug. Dirty plugs can cause fire or electric shock.
- **Do not** pull power cord to unplug unit. Hold the plug firmly and pull it from the outlet. Pulling directly on the cord can damage it, which can lead to fire or electric shock.  
**Do not** modify the length of the power supply cord or use an extension cord to power the unit.
- **Do not** share the electrical outlet with other appliances. Improper or insufficient power supply can cause fire or electrical shock. Always install circuit breaker and a dedicated power circuit.
- **Do not** use the socket if it is loose or damaged.
- **Do not** place heavy object on the power cord and ensure that the cord is not compressed.  
There is danger of fire or electric shock.
- If water enters the unit, turn the unit off at the power outlet and switch off the circuit breaker.  
Isolate supply by taking the power-plug out or disconnect the power supply to the unit, contact a qualified service technician.
- The product must be properly grounded at the time of installation, or electrical shock may occur.
- For all electrical work, follow all local and national wiring standards, regulations, and the Electrical Connection Diagram located on the top panel of the unit.
- If connecting power to fixed wiring, an all-pole disconnection device which has at least 3mm clearances in all poles, and have a leakage current that may exceed 10mA, the residual current device(RCD) having a rated residual operating current not exceeding 30mA, and disconnection must be incorporated in the fixed wiring in accordance with the wiring rules.
- This unit is earthed through the power cord, make sure that the unit is correctly grounded. The wall outlet(Air-break switch) should be provided with reliable earth wire.
- The unit should be provided with an individual circuit and the circuit breaker/fuse rating should be the same as that of the power cord and wall outlet. Power cord conductors are distinguished according to the color as shown in Wiring Diagram located on the top of the machine.

Wall outlet

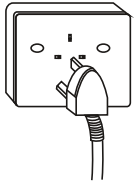

Air-break switch

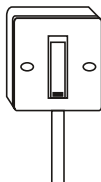

## TAKE NOTE OF FUSE SPECIFICATIONS

The air conditioner's circuit board (PCB) is designed with a fuse to provide overcurrent protection. The specifications of the fuse are printed on the circuit board, such as 220V.



## WARNINGS FOR PRODUCT INSTALLATION

1. Installation must be performed by an authorized dealer or trained specialist. Defective installation can cause water leakage, electrical shock, or fire.
2. Installation must be performed according to the installation instructions. Improper installation can cause water leakage, electrical shock, or fire. (In North America, installation must be performed in accordance with the requirement of NEC and CEC by authorized personnel only.)
3. Contact an authorized service technician for repair or maintenance of this unit. This appliance shall be installed in accordance with national wiring regulations.
4. Only use the included accessories, parts, and specified parts for installation. Using non-standard parts can cause water leakage, electrical shock, fire, and can cause the unit to fail.
5. Install the unit in a firm location that can support the unit's weight. If the chosen location cannot support the unit's weight, or the installation is not done properly, the unit may drop and cause serious injury and damage.
6. Install drainage piping according to the instructions in this manual. Improper drainage may cause water damage to your home and property.
7. For units that have an auxiliary electric heater, do not install the unit within 1 meter (3 feet) of any combustible materials.
8. **Do not** install the unit in a location that may be exposed to combustible gas leaks. If combustible gas accumulates around the unit, it may cause fire.
9. **Do not** turn on the power until all work has been completed.
10. When moving or relocating the air conditioner, consult experienced service technicians for disconnection and reinstallation of the unit.
11. How to install the appliance to its support, please read the information for details in "Installation instructions" section.



## UV-C lamp(Applicable to the unit contains an UV-C lamp only)

This appliance contains a UV-C lamp. Read the maintenance instructions before opening the appliance.

1. Do not operate UV-C lamps outside of the appliance.
2. Appliances that are obviously damaged must not be operated.
3. Unintended use of the appliance or damage to the housing may result in the escape of dangerous UV-C radiation. UV-C radiation may, even in small doses, cause harm to the eyes and skin.
4. Before opening doors and access panels bearing the ULTRAVIOLET RADIATION hazard symbol for the conducting USER MAINTENANCE, it is recommended to disconnect the power.
5. The UV-C lamp can not be cleaned, repaired and replaced.
6. UV-C BARRIERS bearing the ULTRAVIOLET RADIATION hazard symbol should not be removed.

**⚠ WARNING** This appliance contains an UV emitter. Do not stare at the light source.

## **⚠ WARNING for Using R32 Refrigerant**

- Do not use means to accelerate the defrosting process or to clean, other than those recommended by the manufacturer.
- The appliance shall be stored in a room without continuously operating ignition sources (for example: open flames, an operating gas appliance) and ignition sources (for example: an operating electric heater) close to the appliance. The appliance shall be stored in a room without continuously operating ignition sources (for example: open flames, an operating gas appliance or an operating electric heater).
- Do not pierce or burn.
- Be aware that the refrigerants may not contain an odour.
- Compliance with national gas regulations shall be observed.
- Keep ventilation openings clear of obstruction.
- The appliance shall be stored so as to prevent mechanical damage from occurring.
- A warning that the appliance shall be stored in a well-ventilated area where the room size corresponds to the room area as specified for operation.
- Any person who is involved with working on or breaking into a refrigerant circuit should hold a current valid certificate from an industry-accredited assessment authority, which authorises their competence to handle refrigerants safely in accordance with an industry recognised assessment specification.
- Servicing shall only be performed as recommended by the equipment manufacturer. Maintenance and repair requiring the assistance of other skilled personnel shall be carried out under the supervision of the person competent in the use of flammable refrigerants.
- Please follow the instruction carefully to handle, install, clear, service the air conditioner to avoid any damage or hazard. Mildly Flammable Refrigerant R32 is used within air conditioner. When maintaining or disposing the air conditioner, the refrigerant (R32) shall be recovered properly, shall not discharge to air directly.
- No any open fire or device like switch which may generate spark/arcing shall be around air conditioner to avoid causing ignition of the flammable refrigerant used. Please follow the instruction carefully to store or maintain the air conditioner to prevent mechanical damage from occurring.
- Mildly Flammable refrigerant is used in air conditioner. Please follow the instruction carefully to avoid any hazard.





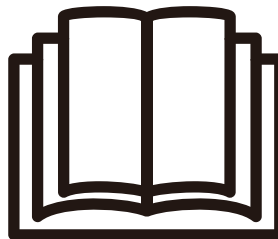

**Warning: low burning velocity material**  
(For R32 models apply to IEC60335-2-40:2018)



**IMPORTANT NOTE: Read this manual carefully before installing or operating your new air conditioning unit.**

## Explanation of symbols displayed on the unit(For the unit adopts R32 Refrigerant only):

	<b>WARNING</b>	This symbol shows that this appliance used a mildly flammable refrigerant. If the refrigerant is leaked and exposed to an external ignition source, there is a risk of fire.		<b>CAUTION</b>	This symbol shows that a service personnel should be handling this equipment with reference to the installation manual.
	<b>CAUTION</b>	This symbol shows that the user's manual should be read carefully.		<b>CAUTION</b>	This symbol shows that information is available such as the user's manual or installation manual.

### 1.Transport of equipment containing flammable refrigerants

See transport regulations

### 2.Marking of equipment using signs

See local regulations

### 3.Disposal of equipment using flammable refrigerants

See national regulations.

### 4.Storage of equipment/appliances

The storage of equipment should be in accordance with the manufacturer's instructions.

### 5.Storage of packed (unsold) equipment

Storage package protection should be constructed such that mechanical damage to the equipment inside the package will not cause a leak of the refrigerant charge.The maximum number of pieces of equipment permitted to be stored together will be determined by local regulations.

### 6.Information on servicing

#### 1)Checks to the area

Prior to beginning work on systems containing flammable refrigerants, safety checks are necessary to ensure that the risk of ignition is minimised. For repair to the refrigerating system, the following precautions shall be complied with prior to conducting work on the system.

#### 2)Work procedure

Work shall be undertaken under a controlled procedure so as to minimise the risk of a flammable gas or vapour being present while the work is being performed.

#### 3)General work area

All maintenance staff and others working in the local area shall be instructed on the nature of work being carried out. Work in confined spaces shall be avoided. The area around the workspace shall be sectioned off. Ensure that the conditions within the area have been made safe by control of flammable material.

#### 4)Checking for presence of refrigerant

The area shall be checked with an appropriate refrigerant detector prior to and during work, to ensure the technician is aware of potentially flammable atmospheres. Ensure that the leak detection equipment being used is suitable for use with flammable refrigerants, i.e. non-sparking, adequately sealed or intrinsically safe.

#### 5)Presence of fire extinguisher

If any hot work is to be conducted on the refrigeration equipment or any associated parts,appropriate fire extinguishing equipment shall be available to hand. Have a dry powder or CO<sub>2</sub> fire extinguisher adjacent to the charging area.

#### 6)No ignition sources

No person carrying out work in relation to a refrigeration system which involves exposing any pipe work that contains or has contained flammable refrigerant shall use any sources of ignition in such a manner that it may lead to the risk of fire or explosion. All possible ignition sources, including cigarette smoking, should be kept sufficiently far away from the site of installation, repairing, removing and disposal, during which flammable refrigerant can possibly be released to the surrounding space. Prior to work taking place, the area around the equipment is to be surveyed to make sure that there are no flammable hazards or ignition risks. No Smoking signs shall be displayed.

#### 7)Ventilated area

Ensure that the area is in the open or that it is adequately ventilated before breaking into the system or conducting any hot work. A degree of ventilation shall continue during the period that the work is carried out. The ventilation should safely disperse any released refrigerant and preferably expel it externally into the atmosphere.

#### 8)Checks to the refrigeration equipment

Where electrical components are being changed, they shall be fit for the purpose and to the correct specification. At all times the manufacturer's maintenance and service guidelines shall be followed. If in doubt consult the manufacturer's technical department for assistance. The following checks shall be applied to installations using flammable refrigerants:

The charge size is in accordance with the room size within which the refrigerant containing parts are installed;

The ventilation machinery and outlets are operating adequately and are not obstructed;

If an indirect refrigerating circuit is being used, the secondary circuit shall be checked for the presence of refrigerant;

Marking to the equipment continues to be visible and legible. Markings and signs that are illegible shall be corrected; Refrigeration pipe or components are installed in a position where they are unlikely to be exposed to any substance which may corrode refrigerant containing components, unless the components are constructed of materials which are inherently resistant to being corroded or are suitably protected against being so corroded.

#### 9) Checks to electrical devices

Repair and maintenance to electrical components shall include initial safety checks and component inspection procedures. If a fault exists that could compromise safety, then no electrical supply shall be connected to the circuit until it is satisfactorily dealt with. If the fault cannot be corrected immediately but it is necessary to continue operation, an adequate temporary solution shall be used. This shall be reported to the owner of the equipment so all parties are advised.

Initial safety checks shall include:

- That capacitors are discharged: this shall be done in a safe manner to avoid possibility of sparking;
- That there no live electrical components and wiring are exposed while charging, recovering or purging the system;
- That there is continuity of earth bonding.

#### 7. Repairs to sealed components

1) During repairs to sealed components, all electrical supplies shall be disconnected from the equipment being worked upon prior to any removal of sealed covers, etc. If it is absolutely necessary to have an electrical supply to equipment during servicing, then a permanently operating form of leak detection shall be located at the most critical point to warn of a potentially hazardous situation.

2) Particular attention shall be paid to the following to ensure that by working on electrical components, the casing is not altered in such a way that the level of protection is affected. This shall include damage to cables, excessive number of connections, terminals not made to original specification, damage to seals, incorrect fitting of glands, etc.

Ensure that apparatus is mounted securely.

Ensure that seals or sealing materials have not degraded such that they no longer serve the purpose of preventing the ingress of flammable atmospheres. Replacement parts shall be in accordance with the manufacturer's specifications.

NOTE: The use of silicon sealant may inhibit the effectiveness of some types of leak detection equipment. Intrinsically safe components do not have to be isolated prior to working on them.

#### 8. Repair to intrinsically safe components

Do not apply any permanent inductive or capacitance loads to the circuit without ensuring that this will not exceed the permissible voltage and current permitted for the equipment in use. Intrinsically safe components are the only types that can be worked on while live in the presence of a flammable atmosphere. The test apparatus shall be at the correct rating. Replace components only with parts specified by the manufacturer. Other parts may result in the ignition of refrigerant in the atmosphere from a leak.

#### 9. Cabling

Check that cabling will not be subject to wear, corrosion, excessive pressure, vibration, sharp edges or any other adverse environmental effects. The check shall also take into account the effects of aging or continual vibration from sources such as compressors or fans.

#### 10. Detection of flammable refrigerants

Under no circumstances shall potential sources of ignition be used in the searching for or detection of refrigerant leaks.

A halide torch (or any other detector using a naked flame) shall not be used.

#### 11. Leak detection methods

The following leak detection methods are deemed acceptable for systems containing flammable refrigerants. Electronic leak detectors shall be used to detect flammable refrigerants, but the sensitivity may not be adequate, or may need recalibration. (Detection equipment shall be calibrated in a refrigerant-free area.) Ensure that the detector is not a potential source of ignition and is suitable for the refrigerant used. Leak detection equipment shall be set at a percentage of the LFL of the refrigerant and shall be calibrated to the refrigerant employed and the appropriate percentage of gas (25 % maximum) is confirmed. Leak detection fluids are suitable for use with most refrigerants but the use of detergents containing chlorine shall be avoided as the chlorine may react with the refrigerant and corrode the copper pipe-work. If a leak is suspected, all naked flames shall be removed/ extinguished. If a leakage of refrigerant is found which requires brazing, all of the refrigerant shall be recovered from the system, or isolated (by means of shut off valves) in a part of the system remote from the leak. Oxygen free nitrogen (OFN) shall then be purged through the system both before and during the brazing process.

#### 12. Removal and evacuation

When breaking into the refrigerant circuit to make repairs or for any other purpose conventional procedures shall be used. However, it is important that best practice is followed since flammability is a consideration. Opening of the refrigeration systems shall not be done by brazing. The following procedure shall be adhered to:

Remove refrigerant;

Purge the circuit with inert gas;

Evacuate;

Purge again with inert gas;

Open the circuit by cutting or brazing.

The refrigerant charge shall be recovered into the correct recovery cylinders. The system shall be flushed with OFN to

render the unit safe. This process may need to be repeated several times. Compressed air or oxygen shall not be used for this task.

Flushing shall be achieved by breaking the vacuum in the system with OFN and continuing to fill until the working pressure is achieved, then venting to atmosphere, and finally pulling down to a vacuum. This process shall be repeated until no refrigerant is within the system.

When the final OFN charge is used, the system shall be vented down to atmospheric pressure to enable work to take place. This operation is absolutely vital if brazing operations on the pipe-work are to take place.

Ensure that the outlet for the vacuum pump is not close to any ignition sources and there is ventilation available.

### **13. Charging procedures**

In addition to conventional charging procedures, the following requirements shall be followed. Ensure that contamination of different refrigerants does not occur when using charging equipment. Hoses or lines shall be as short as possible to minimise the amount of refrigerant contained in them.

Cylinders shall be kept upright.

Ensure that the refrigeration system is earthed prior to charging the system with refrigerant.

Label the system when charging is complete (if not already).

Extreme care shall be taken not to overfill the refrigeration system.

Prior to recharging the system it shall be pressure tested with OFN. The system shall be leak tested on completion of charging but prior to commissioning. A follow up leak test shall be carried out prior to leaving the site.

### **14. Decommissioning**

Before carrying out this procedure, it is essential that the technician is completely familiar with the equipment and all its detail. It is recommended good practice that all refrigerants are recovered safely. Prior to the task being carried out, an oil and refrigerant sample shall be taken in case analysis is required prior to re-use of reclaimed refrigerant. It is essential that electrical power is available before the task is commenced.

a) Become familiar with the equipment and its operation.

b) Isolate system electrically.

c) Before attempting the procedure ensure that:

Mechanical handling equipment is available, if required, for handling refrigerant cylinders;

All personal protective equipment is available and being used correctly;

The recovery process is supervised at all times by a competent person;

Recovery equipment and cylinders conform to the appropriate standards.

d) Pump down refrigerant system, if possible.

e) If a vacuum is not possible, make a manifold so that refrigerant can be removed from various parts of the system.

f) Make sure that cylinder is situated on the scales before recovery takes place.

g) Start the recovery machine and operate in accordance with manufacturer's instructions.

h) Do not overfill cylinders. (No more than 80 % volume liquid charge).

i) Do not exceed the maximum working pressure of the cylinder, even temporarily.

j) When the cylinders have been filled correctly and the process completed, make sure that the cylinders and the equipment are removed from site promptly and all isolation valves on the equipment are closed off.

k) Recovered refrigerant shall not be charged into another refrigeration system unless it has been cleaned and checked.

### **15. Labelling**

Equipment shall be labelled stating that it has been de-commissioned and emptied of refrigerant. The label shall be dated and signed. Ensure that there are labels on the equipment stating the equipment contains flammable refrigerant.

### **16. Recovery**

When removing refrigerant from a system, either for servicing or decommissioning, it is recommended good practice that all refrigerants are removed safely. When transferring refrigerant into cylinders, ensure that only appropriate refrigerant recovery cylinders are employed. Ensure that the correct number of cylinders for holding the total system charge is available. All cylinders to be used are designated for the recovered refrigerant and labelled for that refrigerant (i.e. special cylinders for the recovery of refrigerant). Cylinders shall be complete with pressure relief valve and associated shut-off valves in good working order. Empty recovery cylinders are evacuated and, if possible, cooled before recovery occurs.

The recovery equipment shall be in good working order with a set of instructions concerning the equipment that is at hand and shall be suitable for the recovery of flammable refrigerants. In addition, a set of calibrated weighing scales shall be available and in good working order. Hoses shall be complete with leak-free disconnect couplings and in good condition. Before using the recovery machine, check that it is in satisfactory working order, has been properly maintained and that any associated electrical components are sealed to prevent ignition in the event of a refrigerant release. Consult manufacturer if in doubt.

The recovered refrigerant shall be returned to the refrigerant supplier in the correct recovery cylinder, and the relevant Waste Transfer Note arranged. Do not mix refrigerants in recovery units and especially not in cylinders. If compressors or compressor oils are to be removed, ensure that they have been evacuated to an acceptable level to make certain that flammable refrigerant does not remain within the lubricant. The evacuation process shall be carried out prior to returning the compressor to the suppliers. Only electric heating to the compressor body shall be employed to accelerate this process. When oil is drained from a system, it shall be carried out safely.

When flammable refrigerant are employed, appliance shall be stored in a well -ventilated area.

## Operating temperature

When your air conditioner is used outside of the following temperature ranges, certain safety protection features may activate and cause the unit to disable.

Cooling operation	Outdoor Temperature	18°C-43°C (64°F-109°F)
	Indoor Temperature	18°C-52°C (64°F-126°F) (For special tropical models)
Heating operation	Outdoor Temperature	-5°C-24°C (23°F-76°F)
	Indoor Temperature	0°C-27°C (32°F-80°F)

To further optimize the performance of your unit, do the following:

- Keep doors and windows closed.
- The capacity of the room air conditioner must fit the room size for efficient and satisfactory operation.
- Do not block air inlets or outlets.
- Regularly inspect and clean air filters.
- If the power supplied to the unit is not plus/minus 10% of the specified rating, the unit may not function and the fuse may blow.
- Noise from the air conditioner will be louder at night than in the daytime. This is because the noise in the surroundings is comparatively low at night. If you feel that the noise is too loud, switch the thermostat to lower numbers.

## UNIT PARTS IDENTIFICATION

NOTE: Different models have different front panels and cabinets. Illustrations in this manual are for explanatory purposes. The actual shape of your indoor unit may be slightly different. The actual shape shall prevail. See the following figures for references:

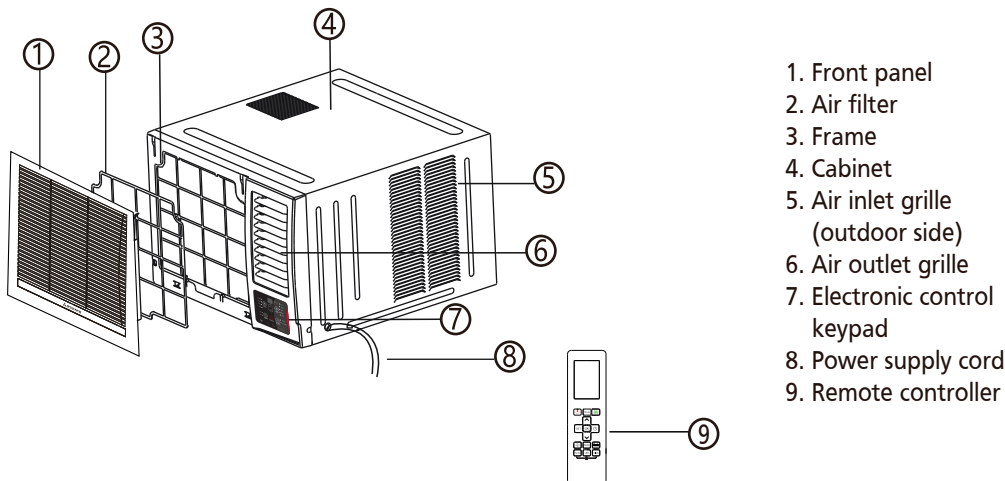

1. Front panel
2. Air filter
3. Frame
4. Cabinet
5. Air inlet grille (outdoor side)
6. Air outlet grille
7. Electronic control keypad
8. Power supply cord
9. Remote controller

### Accessories

Seal(※) (Used on drain joint)	Drain Joint(※)	Drain pan(※)	Rubber Plug	Screw	Wooden screw (optional)(※)	PVC sheath and cable ties(※)
1 pc	1 pc	1 pc	1~2 pc (depending on models)	2 pcs(For some units, used to fasten the front panel) 2 pcs or 4 pcs(used to install the drain pan)	8 pcs (depend on model you purchased)	1 pc    4 pcs
[ ※ ] Model dependent						

## Vent Control

The vent control is located above the control knobs. The operation method and the shape may vary in different models (see the following figures)

For maximum cooling efficiency, CLOSE the vent. It will allow internal air circulation. OPEN the vent to discharge stale air.

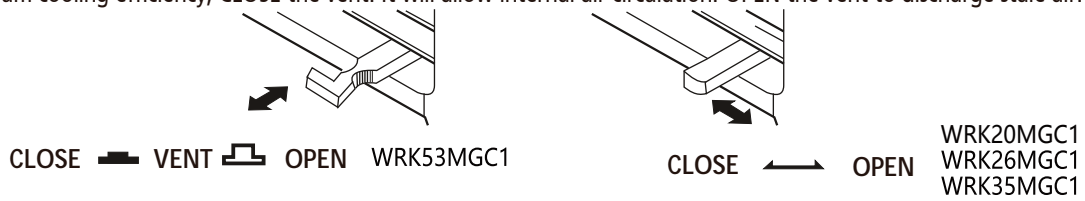

## OPERATING INSTRUCTIONS

**NOTE:** Different models have different operation panels. Not all the functions describing below are available for the air conditioner you purchased. Please check the operation panel of the unit you purchased. The following graphics are for explanatory purposes. The actual shape shall prevail.



WRK20MGC1  
WRK26MGC1  
WRK35MGC1

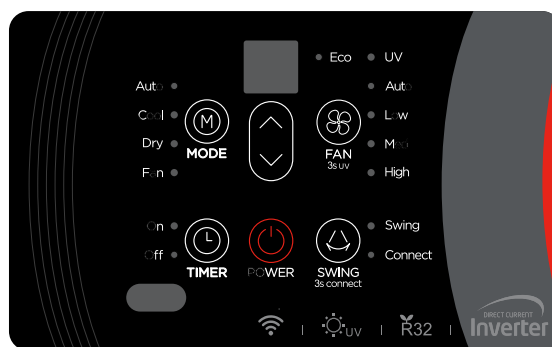

WRK53MGC1

**NOTE:** Some models without MED fan speed feature and (or) AUTO mode feature and (or) swing feature.

**POWER:**

Press the POWER keypad to turn the unit on/off.

**MODE:**

Press the "MODE" keypad to select the appropriate operating mode. The mode selection will alternate between AUTO, HEAT(cooling only models without), COOL, FAN and DRY. The indicator light beside the "MODE" option will illuminate, identifying the mode selected.

**DRY MODE:(on some models)**

This mode is used to decrease the humidity in the room. Under this mode, you cannot select a fan speed. The fan motor operates at LOW speed. Keep windows and doors closed for the best dehumidifying effect.

**NOTE:** On the DRY mode, you can not adjust temperature on some models.

**COOL MODE:**

The temperature setting are adjustable between 17°C to 30°C. You can select your desired fan speed.

**HEAT MODE:(on some models)**

The temperature settings are adjustable between 17°C to 30°C in heating mode. You can select your desired fan speed.

**AUTO MODE:(on some models)**

The fan motor remains on MED speed in AUTO mode. The unit will select the appropriate operating mode from FAN, COOL or HEAT(For reverse cycle models only) based upon the temperature difference between the actual and desired room temperature. Some models without MED speed, the fan motor operates on HIGH speed in AUTO mode.

**NOTE:** On the AUTO mode, you can not both adjust temperature and fan speed for some units.

On the AUTO mode, you just can not adjust fan speed for some units.

**FAN MODE:(on some models)**

Press the "MODE" keypad to select the FAN mode, you can press "FAN" keypad to select your desired fan speed but you can not adjust temperature.

**▲ TEMPERATURE SETTINGS UP:**

Press the ▲ keypad to increase the set (operating) temperature of the unit. Each time the keypad is pressed the temperature increases as follows: 1°C (Celsius Scale) Maximum Setting 30°C.

▼ TEMPERATURE SETTINGS DOWN:

Press the ▼ keypad to decrease the set (operating) temperature of the unit. Each time the keypad is pressed the temperature decreases as follows: 1°C (Celsius Scale) Minimum Setting 17°C.

**FAN:**

Press this keypad to activate the appropriate fan speed setting. Each depression of the keypad will alternate through AUTO(on some models), LOW, MED(on some models), HIGH fan speed options. The indicator light beside the FAN speed option will illuminate, identifying the fan speed selected.

**NOTE:**

For some units press and hold on the FAN button for 3 seconds to initiate UV feature, and the LED display shows 'On' for 3 seconds.

UV(UltraViolet) feature will help to purify the air inside. Press and hold on the FAN button for 3 seconds again to stop UV feature, and the LED display shows 'OF' for 3 seconds.

**SWING:(on some models)**

Press the "SWING" keypad to activate the automatic air swing feature. The indicator light adjacent to the "SWING" keypad will illuminate, identifying the selected mode is operational. The vertical louvers will oscillate back and forth (side to side) automatically sweeping air alternately for comfortable cooling/heating. To stop the air swing feature, press the "SWING" keypad again, the indicator light adjacent to the keypad will go off.

**Wireless operation(on some models):**

For the first time to use APP CONTROL function, press the SWING button for 3 seconds to initiate the APP CONTROL connection mode. The LED DISPLAY shows 'AP' to indicate you can set APP CONTROL connection. If connection(router) is successful within 8 minutes, the unit will exit APP CONTROL connection mode automatically and the Wireless indicator illuminates. If connection is failure within 8 minutes, the unit exits APP CONTROL connection mode automatically.

(Please note that it will not be able to control the air conditioner once it enters 'AP'. To cancel the 'AP', the user can re-start the air conditioner by disconnecting the power of unplugging it)

**TIMER:(on some models)**

- When the unit is on, press the Timer button will initiate the Auto stop program, the TIMER OFF indicator light illuminates. Press the UP or down button to select the desired time. Press the TIMER button again within 10 seconds, the Auto start program is initiated. And the TIMER ON indicator light illuminates. Press the up or down button to select the desired Auto start time.

- When the unit is off, press the Timer button to initiate the Auto start program, press it again within 10 seconds will initiate the Auto stop program.

- Press or hold the UP or DOWN button to change the Auto time by 0.5 hour increments, up to 10 hours, then at 1 hour increments up to 24 hours.

The control will count down the time remaining until start.

- The system will automatically revert back to display the previous temperature setting if there is no operation in a 10 seconds period.

- Turning the unit ON or OFF at any time or adjusting the timer setting to 0.0 will cancel the Auto Start/Stop timer program.

**TIMER:(on some models)**

Press the "TIMER" keypad to activate the "auto start/auto stop" timer function.

Auto start/stop programs can be set from 0~12 hours. Each depression of the "TIMER" keypad will increase the selected time in 1 hour increments.

**SLEEP:(on some models)**

Press and hold the "SWING" keypad for 2 seconds or use the remote control to activate the "SLEEP" feature. Press and hold the "SWING" keypad for 2 seconds or use the remote control again to deactivate the "SLEEP" feature. In the Cooling mode, the cooling temperature set point will increase 1°C per hour after the "SLEEP" mode is selected. Two hours later, the set point will continue at this temperature and the fan motor will remain on LOW speed. In the Heating mode, the heating temperature set point will decrease 1°C per hour after the "SLEEP" mode is selected. Two hours later, the set point will continue at this temperature and the fan motor will remain on LOW speed. For Inverter Type the new temperature will be maintained for 7 hours, then the unit exits sleep mode and is off. Using the "SLEEP" mode will reduce noise creating a comfortable sleeping environment.

**NOTE:** This feature is not available under DRY and FAN ONLY operation.

### Turbo function(on some models)

Press the TURBO button by remote controller on COOL/HEAT (For models adopts Electrical heater only) mode, the air conditioner goes into powerful cooling/heating operation. Press again to cancel the TURBO function.

### ECO function(on some models)

Press the ECO button by remote controller on COOL mode to enter the energy efficient mode.

### LED Display:

- Displays room temperature on fan only mode, displays the setting temperature on the other modes.
- Displays times during Timer setting, after 10 seconds, the system will revert back to display the setting temperature.

### Shows Error codes(inverter type):

E0: Indoor EEPROM error;	F3: Exhaust temperature sensor error;
E1: Communication error between displayboard and maincontrol;	F4: Outdoor electric EE error;
E3: Indoor fan motor speed out of control;	P0: IPM module error;
E4: Room temperature sensor error;	P1: Voltage too high/too low protection;
E5: Evaporator temperature sensor error;	P2: Protection of IPM high temperature;
EC: Refrigerant leakage detection;	P3: Protection of outdoor temperature too low (For the Cooling & Heating models);
F0: Current overload protection;	P4: Protection of compressor location;
F1: Outdoor temperature sensor error;	P7: Outdoor IGBT sensor error.
F2: Condenser temperature sensor error;	

### Shows Error codes(for some units):

Error code appears and begins with the letters as the following in the window display of indoor unit:EH(xx), EL(xx), EC(xx), PH(xx), PL(xx), PC(xx).

**Note:**The unit may stop operation due to a malfunction with the unit. If this occurs, an error code may appear on the display like below. Wait 10 minutes as the problem may resolve itself. If not, disconnect the power, then connect it again. Turn the unit on. If the problem persists, disconnect the power and contact customer service.

## Air direction control

### Horizontal airflow adjustment

#### For the units with manual control lever(Manually)

To adjust horizontal airflow direction, move the lever gently to the left or right by hand until the desired horizontal airflow direction is obtained (see Fig.C).

### Vertical airflow adjustment(Manually)

When the unit is operating, use the hand to adjust the louvers to change the vertical airflow direction. The vertical angle of air flow can be set by gripping the louver and move to the desired position (see Fig.D).

For some units, the connecting rod of the louver is provided with a convex block, it can be moved between the three grooves on the left side of the frame at an angle of 0-15 degrees(see Fig.E).

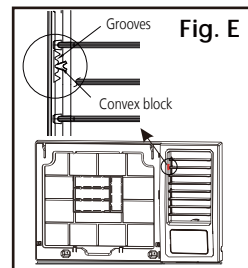
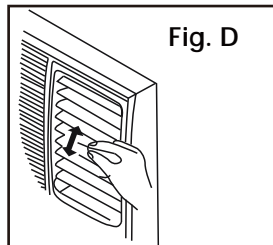
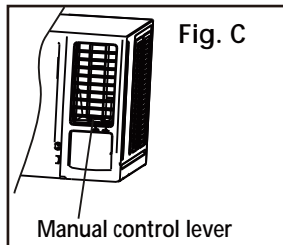



# CARE AND MAINTENANCE



## BEFORE CLEANING OR MAINTENANCE

**ALWAYS TURN OFF YOUR AIR CONDITIONER SYSTEM AND DISCONNECT ITS POWER SUPPLY BEFORE CLEANING OR MAINTENANCE.**

## Cleaning Your Unit



### IMPORTANT

The cabinet and front panel may be dusted with an oil-free cloth or washed with a cloth dampened in a solution of warm water and mild liquid dishwashing detergent. Rinse thoroughly and wipe dry.

- **Do not** use inflammable sprays such as lacquer or hair spray near the air conditioner
- **Do not** use benzene, alcohol, gasoline, acid, paint thinner, polishing powder or other solvents to clean the unit. The unit can be damaged.
- **Do not** use water hotter than 50°C (122°F) to clean the front panel. This can cause the panel to deform or become discolored.
- Excess water in or around the controls may cause damage to the air conditioner. Be sure to wring excess water from the cloth before wipe it clean.

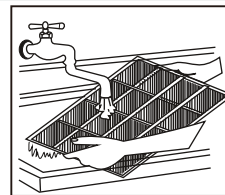
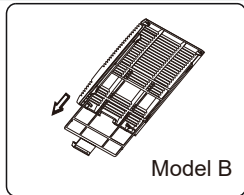
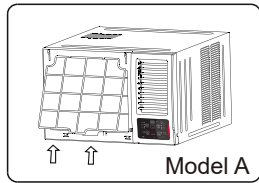
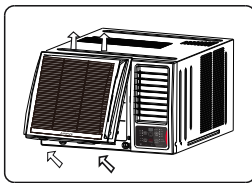

## Cleaning Your Air Filter

A clogged air filter can reduce the cooling efficiency of your unit and increase operating noise. Make sure to clean the filter once every two weeks (or as necessary) during periods of frequent operation.

1. Hold the slot under the front panel, then uplift it outwards, and remove the front panel.
2. Pinch the handle under the air filter and make the air filter arched, remove it from the slot from underside to upside (Model A). Grasp the handle of the filter, then slide it downwards to remove the filter (Model B).
3. Clean the filter with warm, soapy water. The water should be below 40°C (104°F) to prevent distortion of the filter.
4. If your filter has a small air freshening filter, clean this air freshening filter with a hand-held vacuum.
5. Rinse the air filter with fresh water, then shake off excess water.
6. Dry it in a cool, dry place, and refrain from exposing it to direct sunlight.

If your filter has a small air freshening filter (optional), it can be installed at any of the four positions, install it at the position as you like. Clean it with a hand-held vacuum.

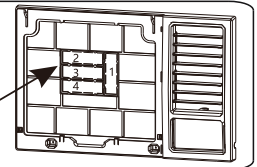

### CAUTION

**NEVER** operate the air conditioner without the air filter, as dust/dirt particles can contribute to equipment failure.

### Winter Storage

If you plan to store the air conditioner during the winter, remove it carefully from the window according to the installation instructions. Cover it with plastic or return it to the original carton.

# WATER DRAINAGE

The condensed water can be treated as follows:

**Bottom drainage** (Applicable for the units designed with bottom drain hole only.)

- Remove the rubber plug from the bottom of cabinet (if any)
- Take out the drain pan and screws from accessory.
- Fix the drain pan onto the bottom of cabinet by screws.
- Connect an extension drain hose (locally purchased) to the outlet of drain tray.

**NOTE:** The bottom drainage will slightly affect cooling performance, but it can reduce the noise caused by spraying the condensed water. For pump heating, the bottom drainage must be chosen.

**Back drainage**

- Fit the seal onto the drain joint (provided as accessory).
- Insert the drain joint to the back drainage hole, and rotate it by 90° to be well fitted.
- Connect an extension drain hose (locally purchased according to the installation length request) to the drain joint.
- Make sure to plug the bottom drain hole by rubber plug.

**NOTE:** The back drainage will slightly affect cooling performance, but will reduce the noise caused by spraying the condensed water.

**Non-drainage**

If you choose non-drainage when cooling, both the bottom and the back drain holes of the unit should be plugged with rubber plugs. The condensed water will be sprayed to condenser, and will improve the cooling performance.

**NOTE:** When you choose non-drainage, the air conditioner will be perfect cooling efficiency, but big noise may be caused by spraying the condensed water, and condensation water dripping may occur when the unit produce excess amounts of water. Please do not choose it if you are sensitive to the noise or being concerned about condensation water dripping problem.

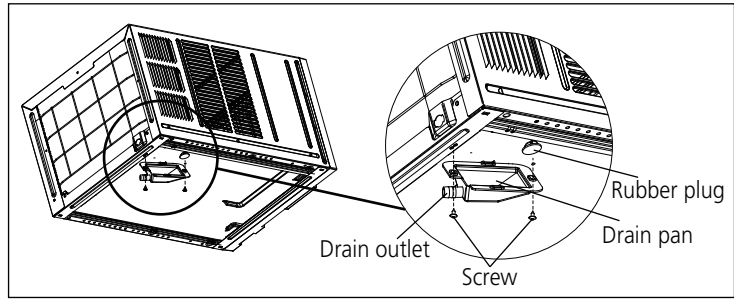
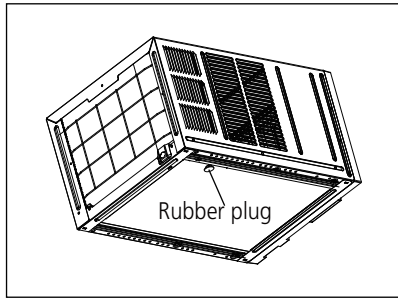

**Bottom drainage**

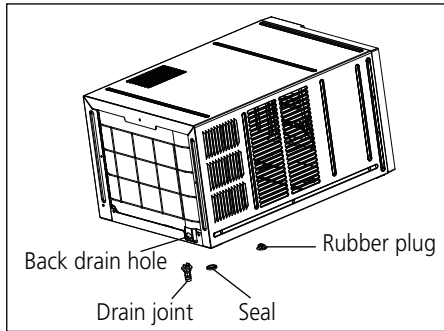

**Back drainage**

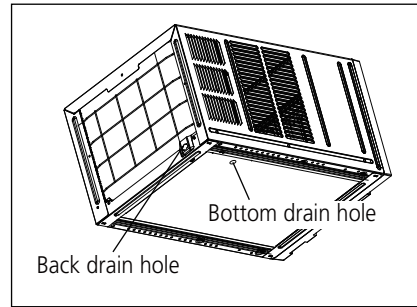

**Non-drainage**

### Note on the product

- The rated cooling performance is tested under non-drainage status.
- Make sure that water will not leak from the surrounding area when rubber plug and joint were used. Please seal it in case leakage is found.

# INSTALLATION INSTRUCTIONS

## Prior to installation

**CAUTION:** Before installing, remove all packaging from inside the carton, along with any inserts placed into the side louvers(if any).

### Step 1: Select the best location

1. To avoid vibration and noise, make sure the unit is installed securely and firmly.
2. Install the unit where the sunlight does not shine directly on the unit. If the unit receives direct sunlight, build an awning to shade the cabinet.
3. There should be no obstacle, such as a fence or wall, within 50cm from the back of the cabinet because it will prevent heat radiation of the condenser. Restriction of outside air will greatly reduce the cooling and heating efficiency of the air conditioner.
4. Install the unit a little obliquely downward to outside not to leak the condensed water into the room (about 3~4°).
5. Install the unit with its bottom portion 75~150cm above the floor level.
6. The power cord must be connected to an independent circuit. The yellow/green wire must be grounded.

### CAUTION

All side louvers of the cabinet must remain exposed to the outside of the structure.

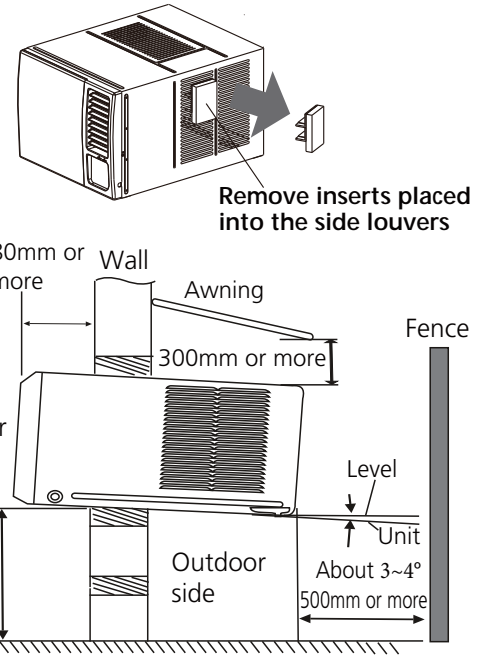

Option A

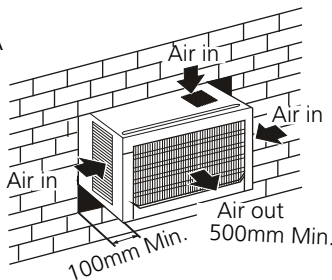

Option B

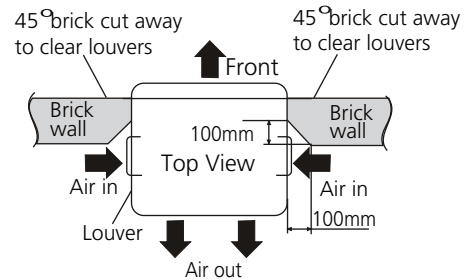

### Step 2: Remove the front panel and air filter

1. Take out the air conditioner from its packaging.
2. Hold the slot under the front panel, then uplift it outwards, and remove the front panel (See Fig. 1)
3. Grip the tab on the end of the filter, lift it up, then pull it towards yourself, pull the filter out (see Fig. 2)

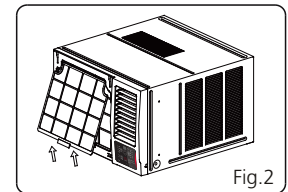
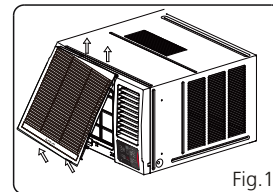

### Step 3: Remove the frame

1. Remove two screws at the bottom of the frame. (See Fig. 3)
2. Disconnect the coupler plugs and make sure not to interfere with the temperature sensor cable. Hold the left bottom side of the frame, lift it up to unlatch the lower side, remove it toward you (See Fig. 4)

NOTE: For some units the front panel and frame do not install on the machine placed at the back of the unit, step 2 and step 3 do not need.

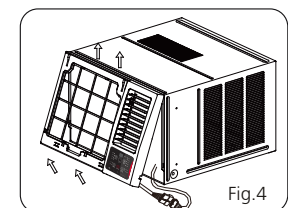
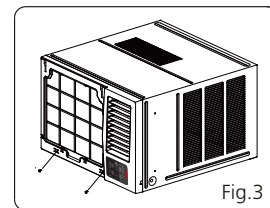

### Step 4: Remove the cabinet

NOTE: There are slight differences on removing the cabinet according to the different models.

#### Model A:

1. Remove one screw securing the chassis fixing bracket, then take down the chassis fixing bracket as shown in Fig.5A.
2. Grasp the handle on the chassis and carefully slide the air conditioner out of the cabinet. (see Fig.6)

#### Model B:

1. Remove one screw securing the chassis fixing bracket, then take down the chassis fixing bracket. Remove two screws located on the back of the cabinet as shown in Fig.5B.
2. Grasp the handle on the chassis and carefully slide the air conditioner out of the cabinet. (see Fig.6)

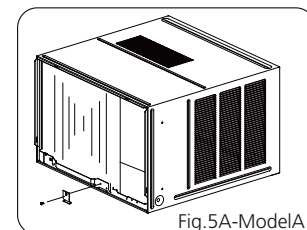

**Model C:**

1. Remove four screws located on both sides and the back of the cabinet as shown in Fig.5C.
2. Grasp the handle on the chassis and carefully slide the air conditioner out of the cabinet.(see Fig.6)

**Model D:**

1. Remove one screw securing the chassis fixing bracket, then take down the chassis fixing bracket.(see Fig.5D)
2. Remove four screws located on both sides and the back of the cabinet as shown in Fig.5D.
3. Grasp the handle on the chassis and carefully slide the air conditioner out of the cabinet.(see Fig.6)

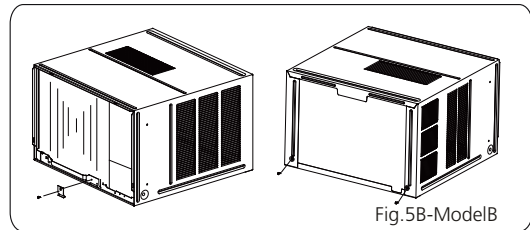

Fig.5B-ModelB

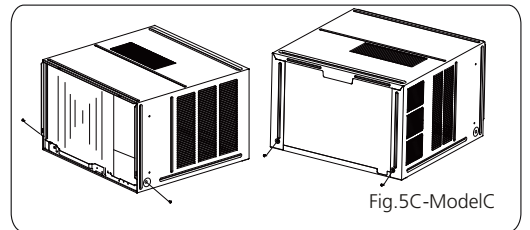

Fig.5C-ModelC

**Step 5: Install the cabinet**

**NOTE:** Unit may be supported by a solid frame from below or by a hanger from a solid overhead support(not supplied, purchase separately, please contact the dealer).

1. When need to drain off water, install the drain plug on the chassis board.
2. Prepare the hole in the wall so that the bottom of the cabinet is well supported, the top has minimum clearance and the air inlet louvers have clearance as shown in previous page(Fig. Option A & B). Holes from the outside through to the cavity should be sealed. The cabinet should slop down towards the rear by about 5~7mm to allow water formed during operation to drain.
3. Install the cabinet into the wall and secure. Ensure the foam seals are not damaged. Flash, seal or fill gaps around the inside and outside to provide satisfactory appearance and protection against the weather, insects and rodents. (see Fig.7)

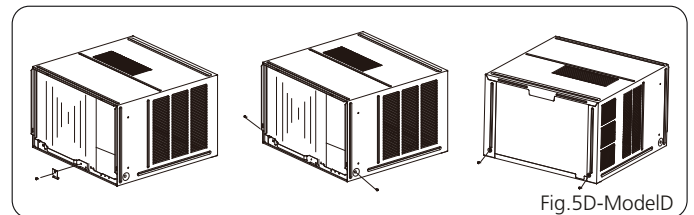

Fig.5D-ModelD

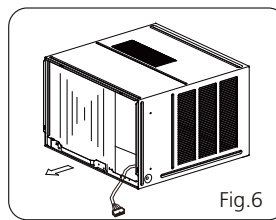

Fig.6

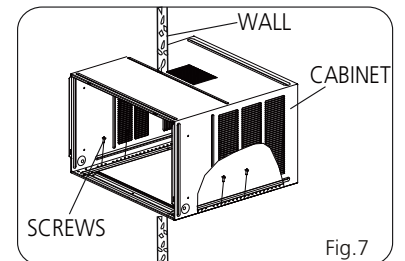

Fig.7

**Step 6: Install the unit into the cabinet**

1. Slide the unit into the cabinet until it is firmly against the rear of the cabinet. Care is required to ensure the foam sealing strips on the cabinet remain in position (See Fig.8).
2. Connect the air conditioner to the power and position excess cord length beneath the air conditioner base.
3. Engage the chassis fixing brackets into the bottom cabinet rail and secure to the base with the screw provided.

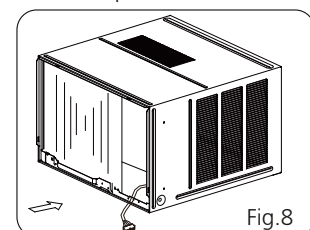
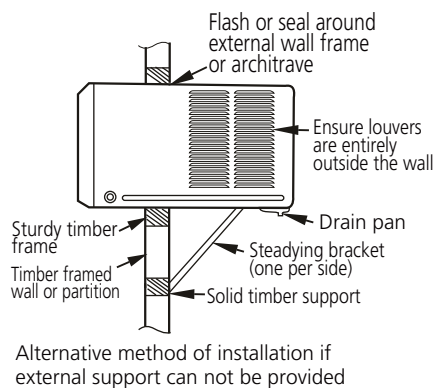
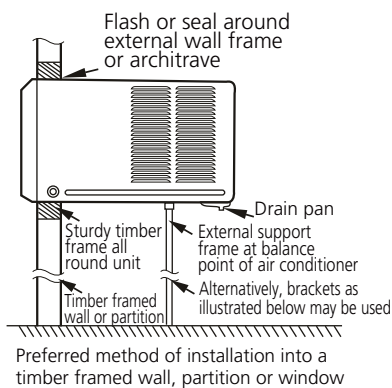

Fig.8

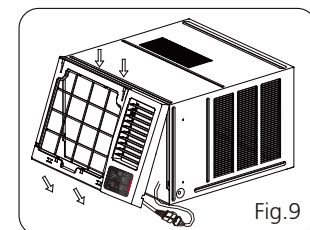

Fig.9

**Step 7: Install the frame**

1. Hook the upper edge of the frame. Then connect the coupler plugs and make sure not to interfere with the temperature sensor cable(see Fig.9).
2. Press the both side and lower edge of the frame, and secure it with the two screws at the bottom of the frame.( See Fig. 10)

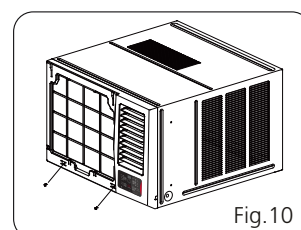
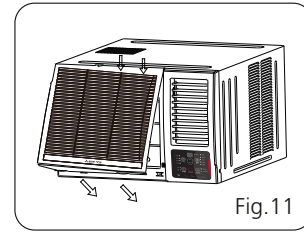

Fig.10

### Step 8: Install the air filter and front panel

1. Insert the air filter into the frame's slot from upside to underside.  
(See Fig. 2)
2. Hang the front panel on the frame's buckle, then press the front panel into the frame's slot until you hear a click (see Fig.11).
3. Switch unit on. Check for operation of the unit and check for vibration after installation.
4. Fit the drain pan to the cabinet and run a drain hose to a suitable location if required.



**NOTE: For the unit with power cord comes out from left side,** please perform the following steps:

1. Pull the power cord to the left side straightly(See Fig.a & b).
2. Wrap the PVC protecting sheath on the power cord with cable ties in the hole position (see Fig.c).
3. Tie up the power cord on the frame (see Fig.d & e) (Applicable for units with body dimension of 600mm\*380mm\*560mm only)
4. Install the frame and front panel according to the above Step 6 and Step 7.

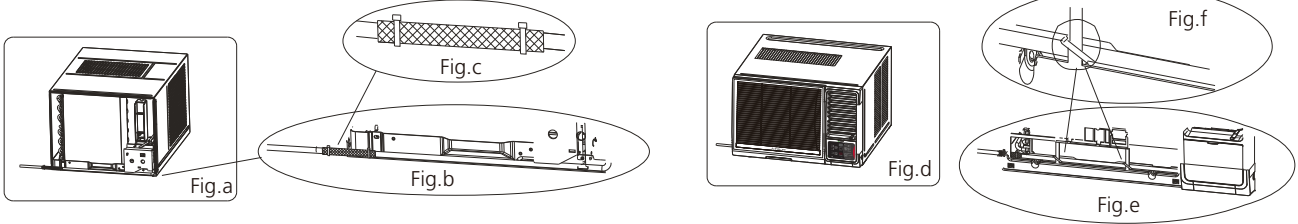

# Troubleshooting



## SAFETY PRECAUTIONS

If ANY of the following conditions occurs, turn off your unit immediately!

- The power cord is damaged or abnormally warm
- You smell a burning odor
- The unit emits loud or abnormal sounds
- A power fuse blows or the circuit breaker frequently trips
- Water or other objects fall into or out of the unit

**DO NOT ATTEMPT TO FIX THESE YOURSELF! CONTACT AN AUTHORIZED SERVICE PROVIDER IMMEDIATELY!**

## Common Issues

The following problems are not a malfunction and in most situations will not require repairs.

Issue	Possible Causes	What To Do
<b>Air conditioner does not start</b>	The air conditioner is unplugged.	- Make sure the air conditioner plug is pushed completely into the outlet and switched on.
	The fuse is blown/circuit breaker is tripped.	- Check the house fuse/circuit breaker box and replace the fuse or reset the breaker.
	Power failure.	- If power failure occurs, switch off and disconnect/unplug the power cord. When power is restored, reconnect (plug in) the power cord, switch on the power and wait 3 minutes to restart the air conditioner to prevent tripping of the compressor overload.
<b>Air conditioner does not cool as it should</b>	Airflow is restricted .	- Make sure there are no curtains, blinds, or furniture blocking the front of the air conditioner.
	The air filter is dirty.	- Clean the filter at least every 2 weeks. - See the operating instructions section.
	The room may have been hot.	- When the air conditioner is first turned on you need to allow time for the room to cool down.
	Cold air is escaping.	- Check for open furnace floor registers and Cold air is escaping. cold air returns. - Set the air conditioner's vent to the closed position.
	Cooling coils have iced up.	- See Air Conditioner Freezing Up below.
<b>Air conditioner freezing up</b>	Ice blocks the air flow and stops the air conditioner from cooling the room.	- Set the fan at MED or HIGH until the ice melts.

# SPECIFICATIONS

## Unit dimensions:

MODEL(Btu/h)	BODY DIMENSION(HxWxD)(mm)
5000~6000	320x415x445
	346x535x450
7000~9000	346x535x450
	346x585x450
	350x450.6x675
9000~12000	350x450.6x675
	350x675x450
	400x640x560
	380x560x600
15000~24000	428x660x780
	428x780x660

**Note:** For the different customization requirements, the depth of the panel may be slightly different. So the dimension of "D" is for reference only.

## Choose the right cable size

The size of the power supply cable, signal cable, fuse, and switch needed is determined by the maximum current of the unit. The maximum current is indicated on the nameplate located on the side panel of the unit. Refer to this nameplate to choose the right cable, fuse, or switch.

### Minimum nominal cross-sectional area of conductors:

Rated Current of Appliance (A)	Nominal Cross-Sectional Area (mm <sup>2</sup> )
> 3 and ≤ 6	0.75
> 6 and ≤ 10	1
> 10 and ≤ 16	1.5
> 16 and ≤ 25	2.5
> 25 and ≤ 32	4
> 32 and ≤ 40	6

**The design and specifications are subject to change without prior notice for product improvement. Consult with the sales agency or manufacturer for details. Any updates to the manual will be uploaded to the service website, please check for the latest version.**

**CW005UI-F(E)RN8**



## 請記錄下列產品資料

型號 Model No.:

機身編號 Serial No.:

經銷商名稱 Dealer:

購買日期 Date of Purchase:

單據編號 Invoice No.:

本產品不斷改進中，如功能有所更改，恕不另行通知。  
如有疑問，請與客戶服務中心聯絡。不便之處，敬請原諒。

The product specifications may be changed without prior notice.  
Please contact customer service for details if necessary.

說明書內容以英文版本為準

If there is any inconsistency or ambiguity  
between the English version and the Chinese version,  
the English version shall prevail.



### 保養登記 Warranty Registration

於網上登記新產品保養 Register your product online  
[www.dchtoolbox.com](http://www.dchtoolbox.com)



客戶服務中心 DCH ToolBox Customer Service Centre  
香港九龍灣啓祥道20號大昌行集團大廈4樓  
4/F, DCH Building, 20 Kai Cheung Road, Kowloon Bay, Hong Kong

客戶服務熱線 Customer Service Hotline: (852) 8210 8210  
電郵地址 E-mail: [8210service@gilman-group.com](mailto:8210service@gilman-group.com)  
網址 Website: [www.gilman-group.com](http://www.gilman-group.com)







---

**MITSUBISHI HEAVY INDUSTRIES - JINLING AIR - CONDITIONERS CO., LTD.**

16120300A32497