

CELLINI italy

Multi-Functional
Tower Fan
多功能直立風扇

MODEL NO./型號: CTF38BD
45W

Before using your product for the first time, please read this instruction manual.
請於使用前細閱本說明書並加以保存

SAFETY INSTRUCTION

Thank you for purchasing this fan. This product has passed through extensive quality assurance process. Every care has been taken to ensure that it reaches you in perfect condition.

Attention! When using electric tools, basic safety precautions should be followed to reduce the risk of fire, electric shock and personal injury, including the following,

Read all these instructions before operating this product and keep these instructions for easy reference.

1. Check the voltage indicated on the rating plate. This fan is designed for a 220-240V~50-60Hz electric supply.
2. Do not use electrical extension cord with this fan.
3. Do not introduce your fingers through the front housing. Do not let children put any objects into the front housing.
4. Do not let hair, curtains, tablecloth, clothes or other objects next to the air outlet of the fan. They could be sucked into the fan, causing damage or injuries.
5. Do not use the fan having a cord or a plug damage, operation failure the fan is fallen or have been damage by any method.
6. Periodically check the electric cable of this fan. If the electric cable is damaged, it must be replaced by the After-sales Service Center or by a similar qualified person in order to avoid a danger.
7. Do not use this fan outdoor.
8. Do not use this fan in a damp area such as bathroom.
9. Do not use this fan on a window.
10. Do not use this fan with any semi-conductors speed control.
11. The fan should not be operated without a base nor used laying on its side.
12. Do not cover the electrical cord by any objects. Do not overlay the cord with little covers or such element. Place the cord in an area where there are not any risk to stumble over it.
13. The fan must be unplugged when not in-use. To unplug the fan, all the switches must be on the position "OFF", and then the plug could be disconnected.
14. Do not operate the fan in an area where gasoline painting or such flammable liquids is used or stocked.
15. Use this fan only as it is describe in this manual.
16. Do not try to disassemble this fan and fix it by user, If you need maintenance, please send back the fan to our After-sales Service Center.
17. All componets of this fan must not be replaced by the user.
18. If the supply cord is damaged, it must be replaced by the After-sales Service Center or a similarly qualified person in order to avoid a hazard.
19. The safety standard of this fan is without earth connection.
20. Keep this fan out of reach from Children or infirm persons and do not let them use the fan without supervision.

WARNING:

1. This appliance can be used by children aged from 8 years and above and persons with reduced physical, sensory or mental capabilities or lack of experience and knowledge if they have been given supervision or instruction concerning use of the appliance in a safe way and understand the hazards involved.
2. Children shall not play with the appliance. Cleaning and user maintenance shall not be made by children without supervised.

NOTE:

There are no serviceable parts in this unit. Do not attempt to disassemble.

WARNING: Never use this fan with any solid-state speed control device. Doing so will create fire and/or shock hazards.

APPLIANCE COMPONENTS



CAUTION: THIS FAN MUST OPERATE IN THE UPRIGHT POSITION ONLY. DO NOT LAY FAN ON ITS SIDE OR IN ANY OTHER POSITION. DOING SO MAY CAUSE DAMAGE TO THE FAN AND/OR PERSONAL PROPERTY. DO NOT USE THIS FAN WITHOUT ITS BASE.

FAN BASE ASSEMBLY

1. Remove all items of packing from the tower fan.
2. Pass the power cord through the middle of the two base pieces.
3. Position base piece onto the support posts of the other base piece to create the base assembly.
4. Turn the tower body upside down position the base assembly onto the pedestal tube. Ensure that the pedestal tube is sitting flush in the base assembly.
5. Screw the base assembly onto the pedestal tube with the supplied screws.

- Position the power cord into the provided cord track in the rear base.
- Turn the tower fan back to upright position. It is now ready for use.

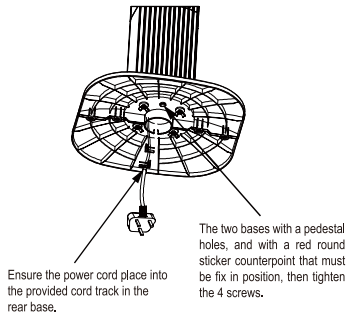
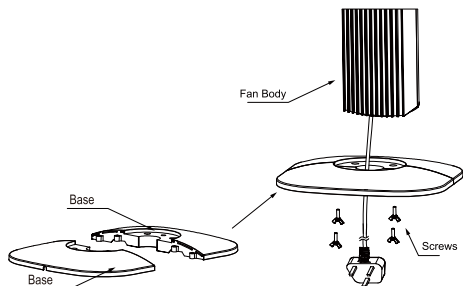

AROMA COMPARTMENT

Aroma box can be fixed in the back of the aroma compartment drop few drops of aroma essential oil into the box if you want to use it.



Aroma compartment and Aroma box

OPERATION

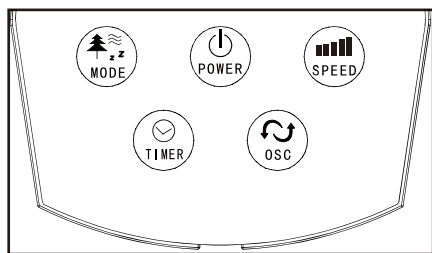



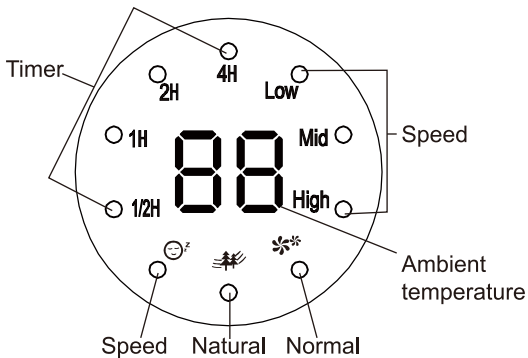







Top Control Panel



LED screen

The fan can be operated by the control panel located on the top of the Fan or by the remote controller.

- Place the Fan on a stable and flat surface. Plug the power cord into a.c. 220 - 240V electrical outlet. The LED screen will display the current ambient temperature °C.
- POWER:** Turn the Fan ON by pressing the POWER  button, the fan will start at Low speed.
- SPEED:** Adjust the Fan speed to the desired level: Low, Medium, or High by pressing SPEED  button. The speed setting is displayed on the LED screen .

4. **MODE:** Press the **MODE**  button to set the Fan as Normal , Natural , or Sleep  mode. The mode is displayed on the LED screen.
5. **OSC:** Press the **OSC**  button to allow the Fan to oscillate the wind direction. To stop the oscillation, press the button again. The maximum angle is 70°.
6. **TIMER:** Press the **TIMER**  button to set the desired auto power off time. There are 7.5 hours intervals, from 0.5 hour to 7.5 hours.
7. **Blue light:** When the fan is ON, the light will switch ON. Press and hold the “SPEED”  button for 3 seconds, the light will turn to OFF. Press and hold the “SPEED”  button for 3 seconds again, the blue light will turn to ON (This function cannot be activated by the remote controller) .

Remote Controller:

1. Remote controller can be stored at the back storage slot of the fan body.
2. Before using the remote controller, remove the plastic protection from the battery.
3. All the functions performed on the Remote Controller work identically to the main Control panel (except switch on and off of the blue light on SPEED button).
4. The remote controller uses the battery(One battery of: CR2025 is included).



FILTER CLEAN & ASSEMBLY

1. Always disconnect the fan from the mains by switching it off and removing the plug from the power outlet before cleaning.
2. Do not allow water to penetrate into the motor during cleaning.
3. Use only a soft or slightly damp cloth to clean the appliance, use a soft brush to clean the air inlet. Never use solvent or abrasives. Do not use very wet substances, liquids or cloths to prevent water entering into the appliance and irreparably damaging it.
4. Clean the air inlet grille cover, filter and air outlet grilles regularly with a vacuum cleaner if it is used frequently.
5. To clean the filter, gently remove the two screws in front of air inlet



- grille cover by screw-driver loosen all the buckles and open the grille. (fig.1).
6. Remove the filter, it lightly to remove the dust or clean the filter by water, after the filter to dry, then replace in the grille cover. (fig.1).
 7. Wrap well and store the appliance in a dry ventilated place after cleaned.
- Note: Never immerse the appliance into the water.

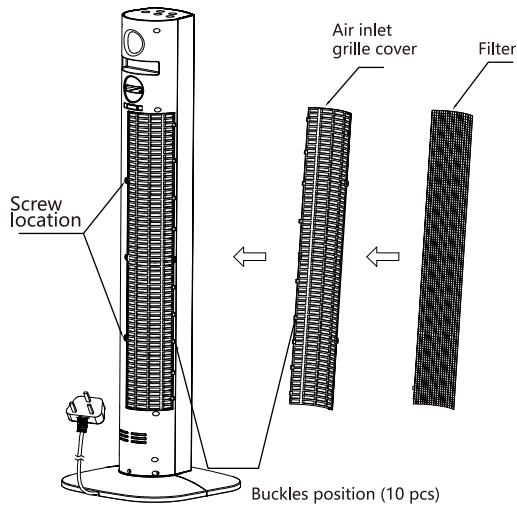



fig.1

CAUTION



The  symbol on the product means that at the end of its life, the appliance must not be considered normal waste but hazardous waste and, as such, must be disposed of in specific recovery and disposal areas, as prescribed by the EC Directive 2002/96/EC (WEEE). By disposing of this product correctly, you can prevent negative consequences for the environment and for human health, due to the presence of potentially hazardous substances in the product.

TECHNICAL DATA

Model No. CTF38BD

Power supply: 220-240V~ 50-60Hz

Power: 45W

Product Dimensions: 310(W)×960(H)×310(D)mm (with base)

Net Weight: 3.0kg

*The final product specification may be varied according to a different lot of material and actual input voltage power of the usage area.

重要安全事項

注意: 當使用電動工具時, 應遵循基本的安全預防措施, 以減少火災, 觸電和人身傷害的風險, 包括以下內容:

首次操作本產品前, 先閱讀所有說明, 並保存各有指示:

1. 檢查銘牌上標示的電壓。本產品應在220-240V~50-60Hz的電力供應中使用。
2. 不要使用電源延長線。
3. 不要把你的手指穿過前方的出風口。不要讓孩子把任何異物插進前方的出風口。
4. 不要讓頭髮、窗簾、桌布、衣服或窗簾旁邊的物件放在的風扇的出風口。它們可能被吸入風扇內, 造成損壞或人身傷害。
5. 如風扇的電源線或插頭。在工作後、風扇跌落地或以任何方式損壞, 不要繼續使用。
6. 定期檢查風扇的電源線。如果電源線損壞, 必須由售後服務部或合格的電器技師更換, 以避免危險。
7. 不要在戶外使用這風扇。
8. 不要在潮濕的地方, 如浴室使用這風扇。
9. 不要在窗口附近使用這風扇。
10. 不要使用任何半導體速度控制器來控制這風扇。
11. 如沒有底座或把風扇橫放都不應操作。
12. 請勿覆蓋電源線。將電源線放於沒有任何絆倒風險下的位置。
13. 風扇不工作時, 請把插頭拔出。在拔走插頭前, 所有的開關必須是在“OFF”位置, 然後才把插頭拔除。
14. 不要在有汽油、油漆或易燃液體的地方使用。
15. 只使用本說明書中描述的方法使用這風扇。
16. 不要試圖拆開這風扇, 用戶不可以自行進行維修。如果您需要維修, 請送回售後服務中心處理。
17. 這風扇的所有部件或零件不可由用戶進行更換。
18. 如果電源線損壞, 必須由售後服務部或合格的電器技師更換。
19. 此風扇的安全技術標準是不可連接地線的。
20. 確保本風扇不可被兒童或體弱者接觸。不要讓他們在沒有監督下使用本產品。

注意:

1. 本產品不是為體質、感覺或智力有障礙人士(包括小孩)或缺乏經驗及知識者使用, 除非他們曾經接受負責安全人士的監督或指導使用此電器。
2. 成年人必須指導小孩不可把玩本電器。

注意：

這風扇沒有可由用戶進行更換的部分，用戶不可自行拆開風扇。

警告：

不要使用非本產品的控制器或硬物來控制這風扇，這會引致火警或觸電。

部件名稱



警告

該風扇僅在直立的位置使用。不要將風扇放側或打平使用。這樣做可能會對風扇造成損壞的和/或對個人做成損失。不要在沒有底座時使用這風扇。

底座安裝方法：

1. 移除所有包裝。
2. 把電源線穿過底座間的兩半圓位置。
3. 把兩塊底板相互扣緊。

4. 把電源線扣於底板指定位置上（其中一塊底板設有電源線安全管道）。
5. 把風扇主體垂直放於底座上，使用四枚螺絲將風扇主體及底座鎖緊並平放在地上使用。

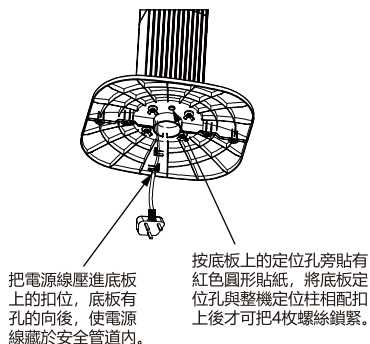
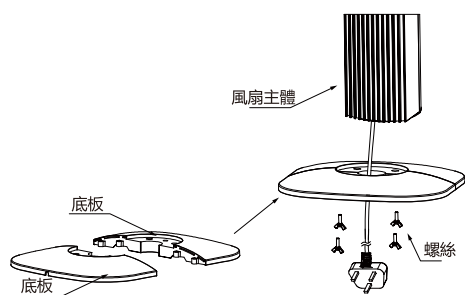

香薰格使用方法

如想風扇送風時帶少許香味，可放幾滴香薰精油於香薰盒內，再把香薰盒插於機背上方的香薰格收藏位置便可。

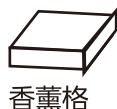

香薰格及收藏位置

使用方法

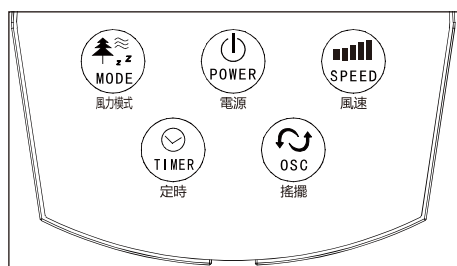



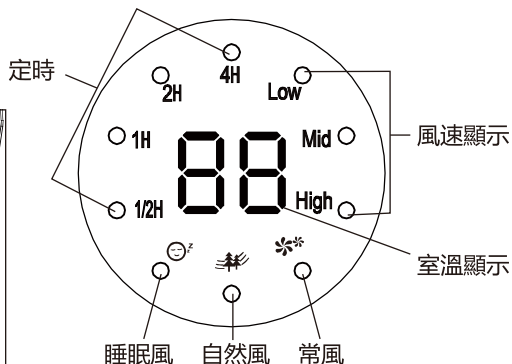





控制面板圖示



LED 顯示屏

風扇可使用機身頂部按鍵操控或用遙控器操控亦可。

1. 將風扇擺放於穩固的平面上，將插頭插入電壓220-240V的獨立插座。室內溫度(°C)顯示燈同時亮起。

2. 開/關(POWER): 按開/關  鍵，風扇以低檔啟動。
3. 風速(SPEED): 按風速  設定鍵，設定所需風速：低、中和高檔。LED顯示屏將會顯示風速圖示。
4. 送風模式(MODE): 按送風模式鍵  設定所需送風模式：常風 、自然風  和睡眠風 。LED顯示屏將會顯示送風模式。
5. 搖擺送風(OSC): 按下搖擺送風鍵 ，風扇以自動左右搖擺模式送風。如欲停止自動搖擺送風，再按此鍵一次。最大角度為70°。
6. 定時設置 (TIMER)：按下定時設置鍵  可選定所需關機時間，分別由0.5至7.5小時，並顯示於LED顯示屏。
7. 頂部藍光燈：長按機身頂部SPEED鍵  3秒，關閉藍光燈，再長按SPEED鍵3秒藍光燈亮起（操控方式不可用於遙控器）。

遙控器:

1. 遙控器收藏可於風扇背部;
2. 使用前將防漏電膠片拔掉;
3. 遙控器操控方式與機頂控制面板操控方式相同（用風速/SPEED鍵控制藍光燈開/關功能外）；
4. 遙控器內已裝上一枚3伏特鋰電池（型號CR2025）。



隔塵網清潔及安裝說明

1. 清理前必須先關掉本機並拔除電源插頭，切斷電源。
2. 清理時切勿將此機浸於水或其他液體中。
3. 僅使用柔軟的濕布擦拭清潔本機。通風口處可用軟毛刷刷淨，切勿使用汽油、石腦油、天那水、酒精、有機溶劑等易揮發的液體清潔本機，及切勿使用鋼刷等堅硬的物體進行清潔，以免對本機造成嚴重傷害。
4. 頻繁使用時，可用吸塵機定期對出入風口進行吸塵清潔。
5. 如需清潔隔塵網，請用十字螺絲刀打開機身後殼部兩粒螺絲，然後推開所有扣位打開後進風網（如圖1）。
6. 取出隔塵網，輕輕清除上面的灰塵，然後再用水清洗乾淨，晾乾後放回原位，把後網所有扣位上緊到位，再鎖上兩粒螺絲（如圖1）。

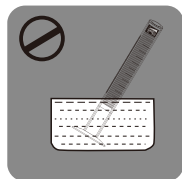

7. 清潔保養完畢後，包好直立風扇，放置在乾燥通風的地方。
注意：切勿直接將整台機器浸入水中清潔。





圖1

 本產品含有可回收材料，不可把本產品作為未分類廢物。
請聯繫就近指定回收點。

產品規格

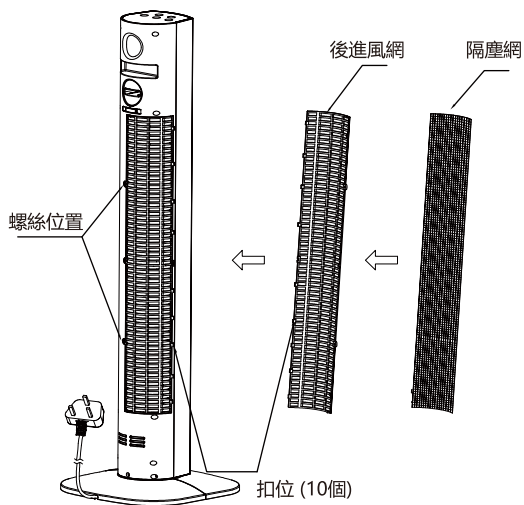
型號：CTF38BD

電源：220-240V~50-60Hz

功率：45 瓦

產品尺寸：310闊×960高×310深 毫米（連底座）

淨重重量：3.0公斤

*相關產品的規格，可能會因配件批次或實際使用地區的電壓差異而有所不同。

請記錄下列產品資料

● 型號

● 機身編號

● 經銷商名稱

● 購買日期

本產品不斷改進中，如功能有所更改，恕不另行通知，如有疑問，請與客戶服務中心聯絡，不便之處，敬請原諒。

說明書內容以英文版本為準

ToolBox Customer Service Centre 客戶服務中心：
4/F, DCH Building, 20 Kai Cheung Road, Kowloon Bay, Hong Kong
香港九龍灣啓祥道20號大昌行集團大廈4樓

Customer Service Hotline 客戶服務熱線：(852) 8210 8210
Service E-mail 電郵地址：8210service@gilman-group.com
Please register now at 請即上網登記：www.toolbox.hk
Website 網址：www.gilman-group.com



Proudly Serviced by:



太平家庭電器