

CELLINI italy

ULTRASONIC MIST FAN WITH IONIZER INSTRUCTION MANUAL MODEL NO.: CMF75S

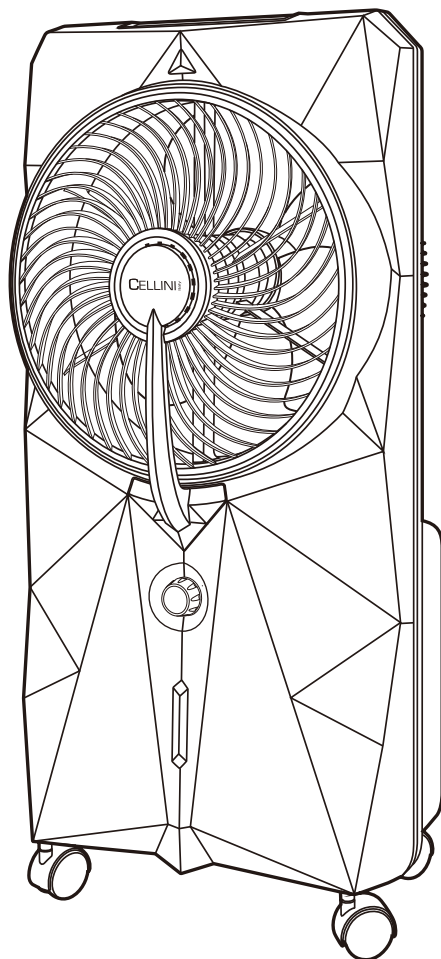

FEATURES

- | | | |
|-------------------------------|---------------------------------|-------------------------------------|
| 1. Remote Controller Sensor | 12. Fan Medium Speed Indicator | 23. Rear Fan Grille |
| 2. Rotary Fan Grille | 13. Fan High Speed Indicator | 24. Fan Blade |
| 3. Misting Outlet | 14. Timer Button | 25. Detachable Water Tank |
| 4. Misting Volume Control | 15. Ionizer Button | 26. Cord Hook |
| 5. Water Level Indicator | 16. Misting ON/OFF Button | 27. Drain Plug |
| 6. Wheel | 17. Timer & Temperature Display | 28. Remote Fan Speed Control Button |
| 7. Timer ON Indicator | 18. Fan Oscillation Button | 29. Remote Timer Button |
| 8. Ionizer ON Indicator | 19. Fan Speed Button | 30. Remote Power ON/OFF Button |
| 9. Misting ON Indicator | 20. Fan Power ON/OFF Button | 31. Remote Misting ON/OFF Button |
| 10. Fan Oscillation Indicator | 21. Power ON/OFF Indicator | 32. Remote Fan Oscillation Button |
| 11. Fan Low Speed Indicator | 22. Handle | 33. Remote Battery Flap |

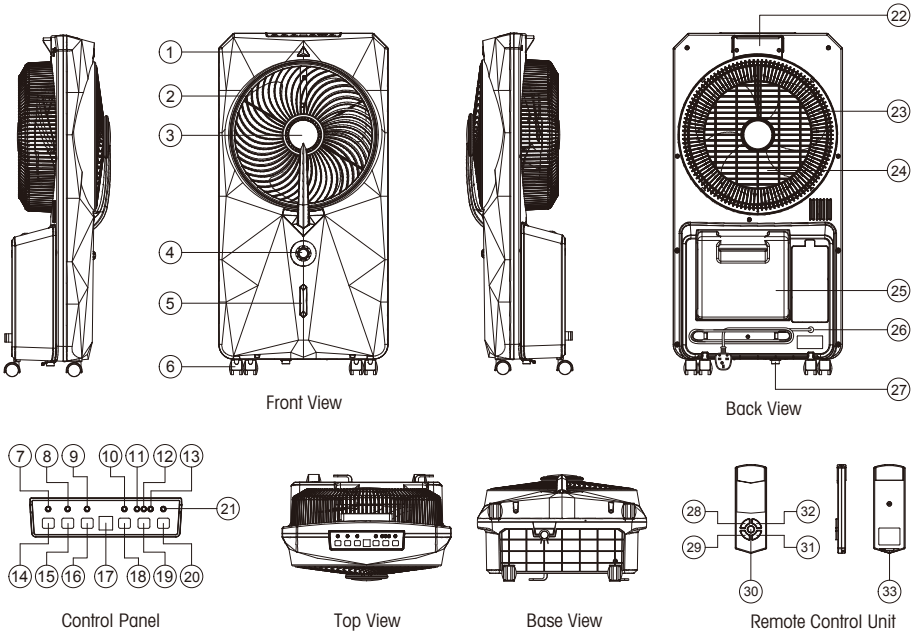

The lightning flash with arrowhead symbol, within an equilateral triangle, is intended to alert the user to the presence of uninsulated, "Dangerous Voltage" within the product's enclosure that may be of sufficient magnitude to constitute a risk of electric shock to persons.



The exclamation point within an equilateral triangle is intended to alert the user to the presence of important operating and maintenance (servicing) instructions in the literature accompanying the appliance.

WARNING: TO REDUCE THE RISK OF FIRE OR ELECTRIC SHOCK, DO NOT EXPOSE THIS APPLIANCE TO RAIN OR MOISTURE.

PRODUCT INTRODUCTION

Misting Fan is design with digital control system. It has device for storing water. It can lower surrounding temperature, freshen the air with equipped ion humidify the air through the principle of water evaporation. LED panel makes it luxurious and easy to use.

IMPORTANT NOTES

Please read the instruction manual carefully before operating this unit.

1. Make sure that the home power supply consistent with the product before plug in.
2. Switch off and disconnect from the power outlet when not in use or before cleaning.
3. Do not expose the unit to rain and keep out of reach of water on the control panel or LED for proper use.
4. Do not put the fingers or any objects inside the fan grill during operation.
5. Do not operate the unit if there is any damage to the power plug or cord - take unit to our after sales service center for repair, do not attempt to undertake any required repairs yourself.
6. Wipe clean with damp cloth only - do not use any abrasive cleaners.
7. This appliance is not intended for use by persons (including children) with reduced physical, sensory, or mental capabilities or lack of experience and knowledge unless then have been given supervision or instruction concerning use of the appliance by a person responsible for their safety.
8. Do not use the misting function if unit is to be used in a damp space.
9. Do not use the misting mode when water tank is empty; always keep enough water in tank in order for this function to operate, otherwise may cause water pump malfunction.
10. If unit is being stored away for a long period of time without use, empty the water tank before storing or transporting the unit.

HOW TO ASSEMBLE THE WHEELS (SEE DRAWING 1)

1. Attach the four wheels into the unit.
2. Two of the wheels can be locked in position if required.

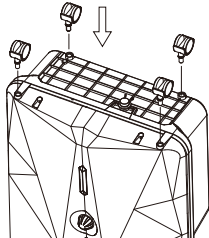

DRAWING 1

MISTING FAN OPERATION - REMOTE & CONTROL PANEL

Make sure that the home power supply is consistent with the product before plug in.

POWER ON/OFF OPERATION

Press the "fan power ON/OFF button"(Feature No. 20) on the control panel or (Feature No.30) on the remote controller to start operation, LED light (Feature No.21) will become illuminated on the control panel. Press the same button to turn off the function.

FAN SPEED OPERATION

Select the required fan speed to Low/Medium/High by press the "Fan Speed Button"(Feature No.19) on the control panel or (Feature No. 28) on the remote control. LED light above selected speed will become illuminated on the control panel.

MISTING OPERATION

1. Ensure the unit is placed on a level surface and unplug from the power and switch off all the function when refilling water.
2. Remove the water tank (Feature No.25) and fill water, but do not fill water over the Marking Line (see drawing 2 below) to ensure water does not overflow.

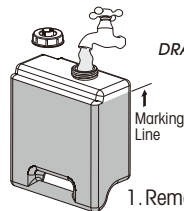

DRAWING 2

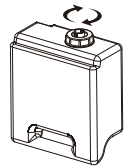

1. Remove the water tank and fill clean water.

2. Tighten the cover in clockwise direction.

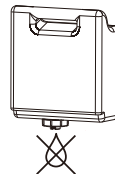

3. Turn the water tank upside down to make sure no leakage.

4. Put the water tank back to the unit.

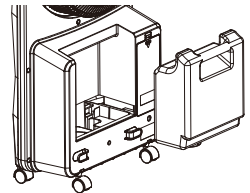

3. Misting function will not operate effectively if water not enough.

- Connect to the power socket, press fan power ON/OFF button, select the fan speed to start and press "Misting ON/OFF Button"(Feature No.16) on the control panel or (Feature No.31) on the remote controller to switch the misting on or off; illuminated lights on the control panel will indicate the functions currently in operation.
- Adjust the mist density, turn the "misting volume control"(Feature No.4) clockwise to increase the mist density or anti-clockwise to decrease the mist density, then get an optimum mist performance as required.
- It may take a minute for a new misting fan to start the misting, it is normal for air to come out of the nozzles before water and the mist.



- Press the "Fan power ON/OFF" button.
- Select the Fan Speed to start.
- Press the "Misting ON/OFF" to start misting.

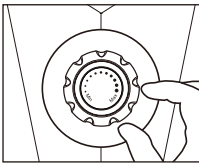

- Adjust the mist density by turning the "Misting volume control" knob.

Warning :

- Low Water Level Alarm:** when water level becomes low, you will hear the "beep" sound and the "Mist Indicator" will flash for a second. At the same time the power of the pump inside the unit will be cut off to protect the life of the pump.
To stop the alarm, turn off the unit from the power outlet.
Fill the tank with water and turn on the unit again.



DRAWING 3

2. DIRECT POUR WATER INTO MIST FAN IS PROHIBITED.(SEE DRAWING 3)

OSCILLATION OPERATION

To start 360° air flow direction, press the "Fan Oscillation Button" (Feature No. 18) on the control panel or (Feature No. 32) on the remote controller once; LED light(Feature No.10) will become illuminated on the control panel and the rotary fan grille will begin to rotate, directing air in a full circle. This setting will be memorized and keep unit next operation. Press the same button to turn off the function.

IONIZER OPERATION

Press the "Ionizer Button" (Feature No. 15) on the control panel to release the anions. Illuminated light is on the control panel will indicate function is currently in operation. Press the same button to turn the function off.

TIMER OPERATION

- Press the "Timer Button" (Feature No. 14) on the control panel or (Feature No. 29) on the remote controller to set the countdown timer. The unit will operate with its present settings until the timer counts down.
- Timer can be set from 1 to 8 hours.
- Once set, LED display will show the time set.
- To switch off the timer function and operate the unit continuously, press the timer button until LED display switches off and the LED light on the control panel above timer button LED will also be off.

REMOTE CONTROLLER

- Open the remote control battery flap (Feature No. 33) and insert 1 piece 3V "CR2032" of Button battery.
- Remote controller must be aimed at the sensor (Feature No.1) on the front of the appliance, distance within 5 meters, and will not function from beside or behind the appliance.

CLEANING AND MAINTENANCE (SEE DRAWING 4)

- Ensure the unit is switched off and disconnected from a power source before cleaning.
- Clean outer casing or control panel with a damp cloth only - do not use any abrasive cleaners or harsh chemicals, and ensure the control panel or LED is out of reach of water.
- Check the condition of misting and water tank before every use.
- After long time operation with this appliance, the unit may become clogged with dust and dirt, which will greatly affect the performance of the unit. Sometimes mold and mildew may also occur due to the water tank not regular cleaned, recommend to clean once every two weeks.

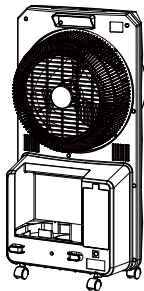

5. Remove the drain plug (Feature No.21) and allow the water tank to empty.
6. If the unit is being stored for a long period of time without use, empty the water tank before storing or transporting the unit.

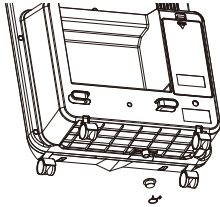

DRAWING 4

TECHNICAL SPECIFICATIONS

Input Voltage	AC220-240V 50/60Hz
Input Power.....	75W
Operating Temperature.....	0°C-45°C
Humidity	Lower than 90%
Water Tank Capacity	4 Liter
Fan Maximum Air Volume.....	Approx > 300m ³ /Hour
Fan Maximum Speed.....	Approx 5.5m/s
Evaporative Contant Of Water	Approx 300mL/Hr
Timer Control.....	1-8 Hours
Remote Control Distance.....	Approx 5 Meters
Ion Density Approx	Approx 3 x 10 ⁶ Ion/cm ³
Product Dimension	Approx W40 x D25 x H80.6cm



This marking indicates that this product should not be disposed with other household wastes throughout the EU. To prevent possible harm to the environment or human health from uncontrolled waste disposal, recycle it responsibly to promote the sustainable reuse of material resources. To return your used device, please use the return and collection systems or contact the retailer where the product was purchased. They can take this product for environmental safe recycling.

WARNING:

- A. To avoid an electrical shock, please do not open the rear cabinet (rechargeable fan) for repair or cleaning unless qualified person.
- B. If the supply cord is damaged, it must be replaced by the manufacturer or its service agent or a similarly qualified person in order to avoid a hazard.
- C. The appliance is not intended for use by persons (including children) with reduced physical, sensory or mental capabilities, or lack of experience and knowledge, unless they have been given supervision or instruction concerning use of the appliance by a person responsible for their safety.
- D. Children should be supervised to ensure that they do not play with the appliance.

CELLINI italy

超聲波冷霧電風扇

帶負離子空氣淨化功能

產品型號: CMF75S

使用說明書

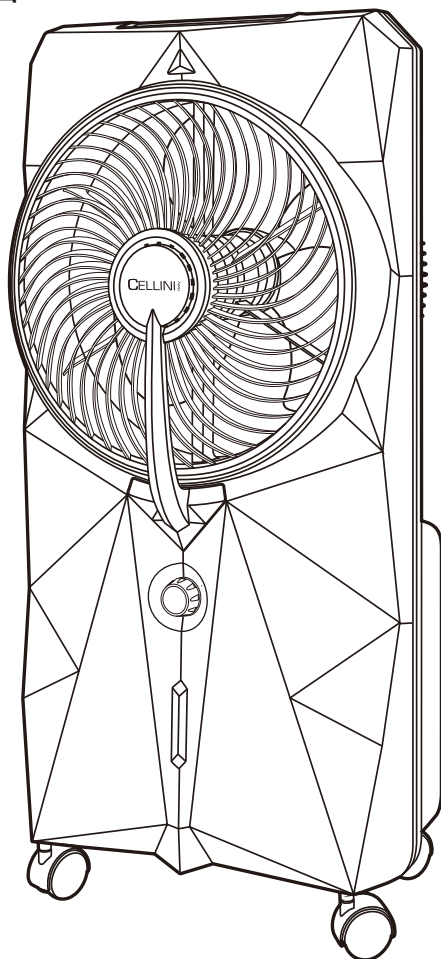

功能及名稱簡介 (圖解)

- | | | |
|--------------|----------------|------------|
| 1. 遙控接收器 | 12. 風扇中速顯示燈 | 23. 導風後網 |
| 2. 導風網 | 13. 風扇高速顯示燈 | 24. 風扇葉 |
| 3. 霧化器 | 14. 定時選擇鍵 | 25. 水箱 |
| 4. 強弱霧化調節器 | 15. 負離子開關 | 26. 電源線收納勾 |
| 5. 水位指示 | 16. 冷霧開關 | 27. 排水塞 |
| 6. 旋轉滑輪 | 17. 定時時間及溫度顯示器 | 28. 風速遙控 |
| 7. 定時顯示燈 | 18. 導風網轉動開關 | 29. 定時遙控 |
| 8. 負離子顯示燈 | 19. 風速選擇鍵 | 30. 電源遙控 |
| 9. 冷霧顯示燈 | 20. 電源開關 | 31. 霧化遙控 |
| 10. 導風網轉動顯示燈 | 21. 電源顯示燈 | 32. 風向遙控 |
| 11. 風扇低速顯示燈 | 22. 手柄 | 33. 遙控器電池蓋 |

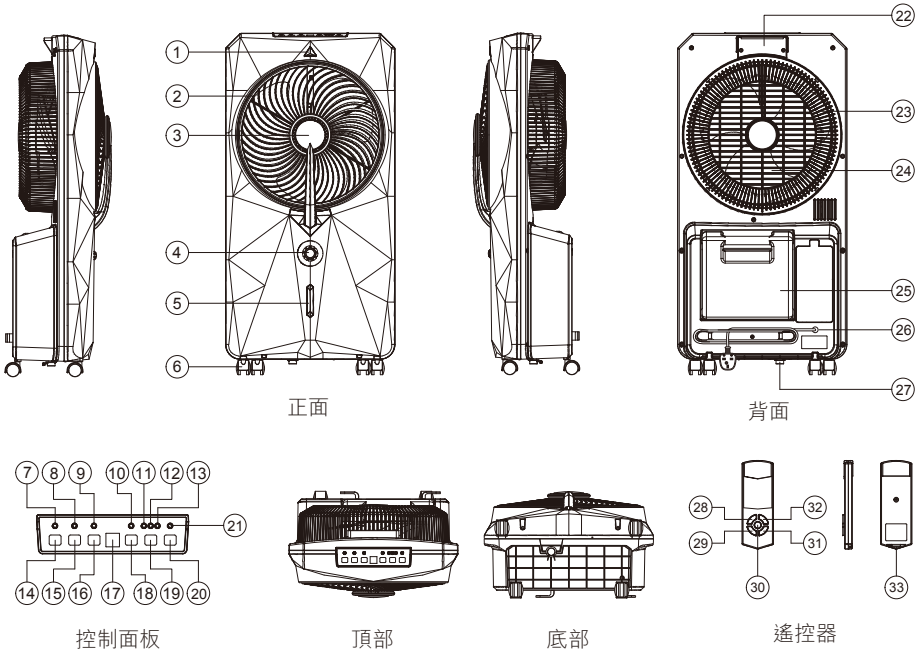

注意：為減少觸電危險，切勿把產品暴露於雨中或潮濕環境中，亦不要拆去後部零件。機身內並無使用者維修的零件，請將維修工作委托給專業資格人員。



三角型內有箭頭的閃電符號旨在提醒使用者，本產品機殼內有未經絕緣的“危險電壓”其幅度足使人觸電而發生危險！



三角型內加感嘆號旨在提醒用戶，有重要的操作與保養說明配合本機，請仔細閱讀後方可使用！

產品特點及適用範圍

1. 新概念風扇，移動方便，外型美觀；
2. 長壽命低噪音電機，節省用電；
3. 兼具送風、淨化空氣、加濕等功能於一體；
4. 旋轉式導風網，加大吹風面積；
5. 負離子空氣淨化器、除塵、除臭，有效阻擋細菌；
6. 超聲波霧化器，提高加濕空氣和降溫功效；
7. 輕觸式按鍵、功能顯示燈及溫度顯示；
8. 適用於家庭使用。

注意事項：

1. 在使用前，必須詳細閱讀此說明書，方可開始接上電源；
2. 本產品的電源性質只能使用220-240V 50-60Hz；
3. 長時間不使用時，插頭電源線應從插座中拔出；
4. 給水箱注水時，應使用純度高的清水。水箱中的水要經常添加，維持充足水量，更要定期進行更換和清洗水箱；
5. 清潔外殼污垢時，請用蘸有稀釋中性洗滌劑的布輕輕擦去污垢，然後再用乾布仔細擦拭，直至光潔。

安裝滑輪：

1. 打開包裝，取出電風扇，按(圖示一)所示，將滑輪裝入機身底部。
2. 如有需要，可鎖定其中兩個滑輪不讓機器移動。

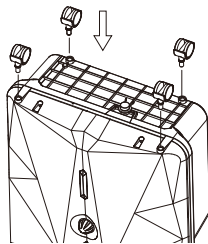

(圖示一)

風扇操作功能

1. 接通電源，顯示燈(圖解21)亮，蜂鳴器響一聲，風扇處於待機狀態。
2. 按本機控制面板“電源開關”按鈕(圖解20)或遙控器“電源遙控”功能(圖解30)，電源顯示燈(圖解8)亮，初次開設定為風扇低速，定時時間及溫度顯示器(圖解17)顯示當前環境溫度。
3. 按本機控制面板“風速選擇鍵”(圖解19)或遙控器“風速遙控”(圖解28)可以選擇風速，風速分高、中、低三檔，同時風速指示燈作相應風速顯示。

4. 按本機控制面板“導風網轉動開關”(圖解18)或遙控器“風向遙控”(圖解32)一次，導風網轉動顯示燈(圖解4)亮，風網開始360°轉動，再按一次停止。

霧化操作功能

1. 補充水的時候，確保本機置於在平面上，拔除電源線，並關閉所有操作功能。
2. 卸下水箱(圖解25)，注水入水箱，注水不要超過(圖示二)的水位指示線，同時確定水不會溢出。
3. 如水量不足夠，噴霧功能將會無法有效操作。

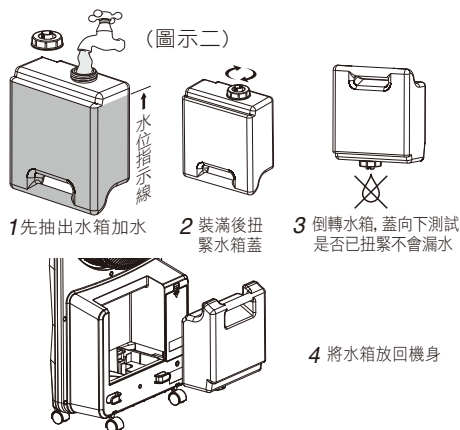

充水完畢後，請重新接駁電線，開啟風扇控制面板上的電源開關，再選擇適合風速正式啟動風扇。

4. 按本機控制面板“霧化開關按鈕”(圖解16)或遙控器上的控制面板(圖解31)，按壓打開或關閉的噴霧功能；面板上的燈亮著時，顯示目前噴霧正在運作。
5. 調節噴霧密度，旋轉本機“霧化調節器”(圖解4)，順時針旋轉增大噴霧密度、逆時針方向以降低噴霧密度，可獲得最佳的霧化性能需求。
6. 每次運行風扇時重啟噴霧功能，可能要等候一分鐘時間噴霧功能才運作，這是正常的。

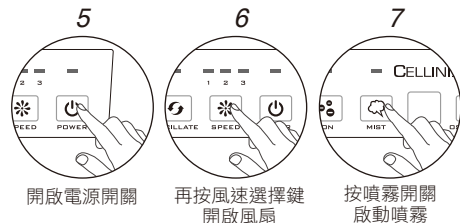

開啟電源開關

再按風速選擇鍵
開啟風扇

按噴霧開關
啟動噴霧

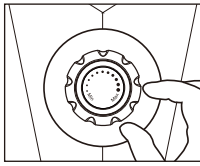

8 調節霧化強弱

警告：

1. 初次啟動時，由於要先排出噴霧喉管內的空氣，噴霧將稍後片刻才能開始運作。
2. 注意缺水保護：當水箱缺水時，蜂鳴器發出報警聲響，且噴霧顯示燈閃爍數秒後熄滅，水泵自動停止工作，加水後重新開啟可恢復操作。
3. 切勿將水直接注入風扇機殼內，會造成噴霧不良。
(圖示三)



(圖示三)

負離子操作

按本機控制面板“負離子開關按鈕”(圖解15)按一次以釋放負離子，顯示燈亮著指示功能正在運行中，如停止使用按下同一按鈕來關閉該功能。

預設時間操作

1. 按定時鍵(圖解14)開啟設置定時功能或遙控器(圖解29)，面板上的顯示燈亮起。
2. 可任意選擇1-8小時定時設置。
3. 定時時間顯示器(圖解17)顯示定時，連續按此鍵，可調整定時時間。
4. 持續按下計時器按鈕，直至LED屏幕關閉和控制面板上的定時LED指示燈熄滅才完成。

遙控操作

本機也可通過遙控操作，遙控器按鍵與控制面板相同。

1. 打開遙控器背部電池蓋裝上一粒3V“CR2032”鈕扣型鋰電池即可使用。
2. 使用遙控器時應對準風扇遙控接收器(圖解1)，有效遙控距離為5米。

保養與清潔(圖示四)

1. 請確保機組已關閉並拔掉電源插頭才可進行清洗，以免發生危險。
2. 清潔外殼或控制面板時只需用濕布，不要使用任何具有研磨作用的清潔劑或刺激性化學品。

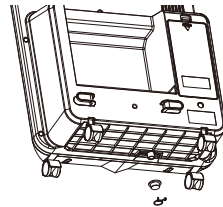

(圖示四)

3. 每次使用前請檢查噴霧及水箱的狀態。
4. 本產品長時間操作後，水箱內部件可能堵塞灰塵和污垢，這將極大影響裝置的性能，建議每兩週清洗一次。
5. 如裝置長時間不使用，需存儲此裝置，請先清空水箱內積水。
6. 按(圖示三)所示卸下排水塞(圖解2-7)可釋放內部積水。

主要技術參數：

1. 電源電壓：220-240V 50-60Hz
2. 額定輸入功率：75W
3. 使用環境溫度：0°C至45°C；
4. 使用周圍空氣相對濕度：小於90%
5. 最大風量：>300M³/Hr
6. 最大風速：5.5m/s
7. 水箱裝水量：4L
8. 噴霧量(水蒸發量)：約300ML/Hr
9. 負離子密度：3 x 10⁶ Ion/cm³
10. 定時器控制：1-8小時
11. 遙控器電池：3V“CR2030”鋰電池 x1粒
12. 遙控器遙控距離：約5米
13. 產品尺寸：約闊40 x 深25 x 高80.6厘米
14. 淨重：約5.8公斤

注意：

- 如果電源線損壞，為避免危險，必須由製造廠或其維修部或類似的專職人員來更換。
- 本產品不預備給體能弱、反應遲緩或有精神障礙的人(包括兒童)使用，除非在對其負有安全責任的人員的指導或幫助下安全使用；
- 兒童應被監督，以保證他們不玩耍此產品。

請記錄下列產品資料

● 型號

● 機身編號

● 經銷商名稱

● 購買日期

本產品不斷改進中，如功能有所更改，恕不另行通知，如有疑問，請與客戶服務中心聯絡，不便之處，敬請原諒。

說明書內容以英文版本為準

ToolBox Customer Service Centre 客戶服務中心：

4/F., DHC Building, 20 Kai Cheung Road, Kowloon Bay, Hong Kong.
香港九龍灣啟祥道20號大昌行集團大廈4樓

Customer Service Hotline 客戶服務熱線：(852) 8210 8210

Service E-mail 電郵地址：8210service@gilman-group.com

Please register now at 請即上網登記：www.toolbox.hk

Website 網址：www.gilman-group.com



Proudly Serviced by:



a Gilman Group Company

太平家庭電器